

PRODUCTCATALOG

PALLETS WITH

A PURPOSE



PLASTIC PALLETS

DEALERS AND PRODUCTION

ACTING GLOBAL SERVING LOCAL

BELGIUM

① **INDUPACK BVBA**
Simon Stevinstraat 11
BE 3920 Lommel
Belgium
Phone : +32 11 40 35 65
E-mail: belgium@qpall.com

DENMARK

② **DANSK TRANSPORT EMBALLAGE A/S**
Postbox 127
Industriparken 6
DK-6500 Vojens
Denmark
Phone: +45 74 59 16 80
E-mail: denmark@qpall.com

GERMANY

③ **ALPHA PALETTE & BOXEN**
Dorfstr. 77
49849 Wilsum
Germany
Phone: +49 5945 99579 0
E-mail: germany@qpall.com

④ EDMUND G. FRIEDRICH & CO. GMBH

Elbchaussee 60 A
22765 Hamburg
Germany
Phone: +49 40 31 29 39
E-mail: germany@qpall.com

⑤ GFH KUNSTSTOFFTECHNIK

Am Peterfeld 4
83024 Rosenheim
Germany
Phone: +49 80312068498
E-mail: germany@qpall.com

⑥ ZÖLLNER KUNSTSTOFFPRODUKTE GMBH

Zur Eisenkaute 12
57299 Burbach
Germany
Phone: +49 2736509700
E-mail: germany@qpall.com

FINLANDE

⑦ **ZYMOTEC OY**
Kinturinkuja 4
11120 Riihimäki
Finland
Phone: +358 19 419 428
E-mail: finland@qpall.com

FRANCE

⑧ **BAC-LAND PACK**
12 avenue Charles de Gaulle
Batiment K
31130 Balma
France
Phone: +33 562 57 88 38
E-mail: france@qpall.com

ITALY

⑨ **CMP SRL**
Via Revello 38
12037 - Saluzzo - CN
Italy
Phone: +39 175 217560
E-mail: italy@qpall.com

THE NETHERLANDS

⑩ **Q-PALL BV HQ**
Taylorweg 2
NL-5466 AE Veghel
The Netherlands
Phone: +31 413 353 111
E-mail: info@qpall.com

NORWAY

⑪ **STROMBERGS PLAST AS**
Postboks 3
Stallbakken 7
NO-2005 Raelingen
Norway
Phone: +47 64 80 29 04
E-mail: norway@qpall.com

UKRAINE

⑫ **OSTTOR PALLETS**
Rokytyanskiy side street 1
Chernivtsi
Ukraine
Phone: +38 372 58 40 85
E-mail: info@qpall.com

AUSTRIA

⑬ **RUMPL GMBH**
Schmiedlstraße 15
8042 Graz
Austria
Phone: +43 316 406 460
E-mail: austria@qpall.com

PORTUGAL

⑭ **CAREPACK - SOLUÇÕES DE EMBALAGEM, LDA.**
Z.I. do Canhestro, R. do Casal-
inho
Armazém 1C - Pousos
2410-478 Leiria
Portugal
Phone: +351 244 095 210
E-mail: portugal@qpall.com

ROMANIA

⑮ **LOGISTIC PACKAGING SRL**
29 Drumul Sarii, Etaj 2
060152, Bucharest
Romania
Phone: +4 021 202 32 38
E-mail: info@qpall.com

SLOVENIA

⑯ **TRICOR D.O.O.**
SV. Lenart 17
SLO-4227 Selca
Slovenia
Phone: + 386 4 257 56 80
E-mail: info@qpall.com

SPAIN

⑰ **OSONA INDUSTRIAL PLASTICS, S.L.**
Carrer Font del buc, 9
PAE Ca l'Avellanet
08554 Sant Miquel de Balenyà
Spain
Phone: +34 93 812 41 96
E-mail: spain@qpall.com

CZECH REPUBLIC - SLOVAKIA

⑱ **GREEN PLANET INVESTMENT, S.R.O.**
Company Head Office:
Piletická 61/36a
Hradec Králové
500 03 Czech Republic
Phone: +420 603 472 169
E-mail: czechia@qpall.com

TURKEY

⑲ **PDA IC VE DIS TICARET LTD. STI.**
Bahri Saritepe Cad. No:51/3
45030 Yunusemre Manisa
Turkey
Phone: +90 236 2362022
E-mail: turkey@qpall.com

United Kingdom

⑳ **ALL PALLETS LTD**
Unit 6b, Alder Close,
Eastbourne, East Sussex
England BN23 6QF
Phone: +44 1323 744057
E-mail: uk@qpall.com

UNITED STATES

㉑ **THE NELSON COMPANY**
4517 North Point Blvd
Baltimore, MD 21219
United States
Phone: +1 410 477 3000
E-mail: us@qpall.com

㉒ TRANPAK

2860 S. East Ave.
Fresno, CA 93725-1909
United States
Phone: +1 800 827 2474
E-mail: us@qpall.com

SWITZERLAND

㉓ **DYNAMEX**
Gewerbestr. 2,
8475 Ossingen
Switzerland
Phone: +41 52 305 20 41
E-mail: switzerland@qpall.com

SWEDEN

㉔ **TOFO TRADING AB**
Tegelvägen 4
SE-382 82 NYBRO
Sweden
Phone: +46 481 140 17
E-mail: sweden@qpall.com

PRODUCTION LOCATIONS

THE NETHERLANDS

① Balk

GERMANY

② Ringe

③ Marktoberdorf

DENMARK

④ Ribe

FRANCE

⑤ Nantes

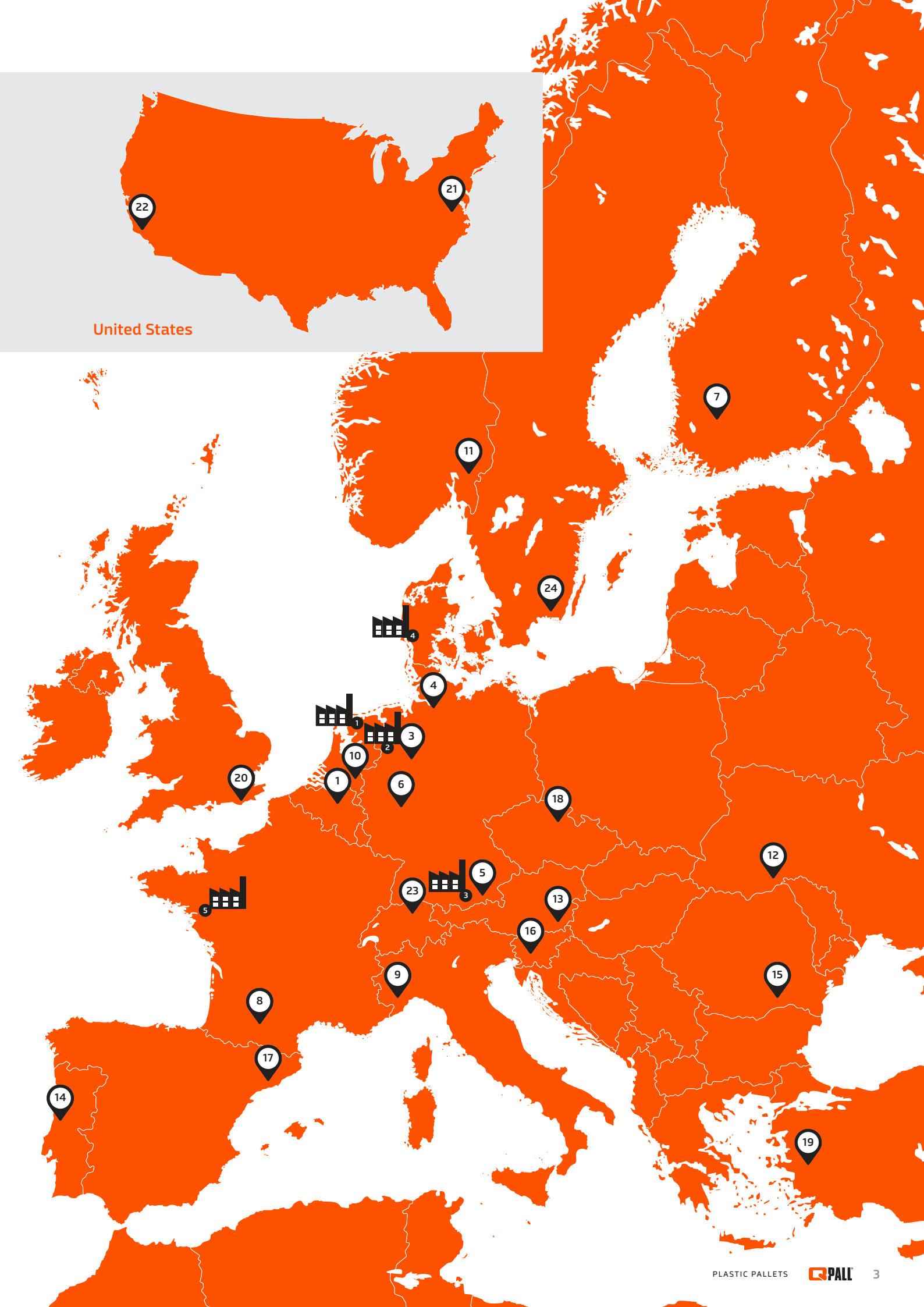
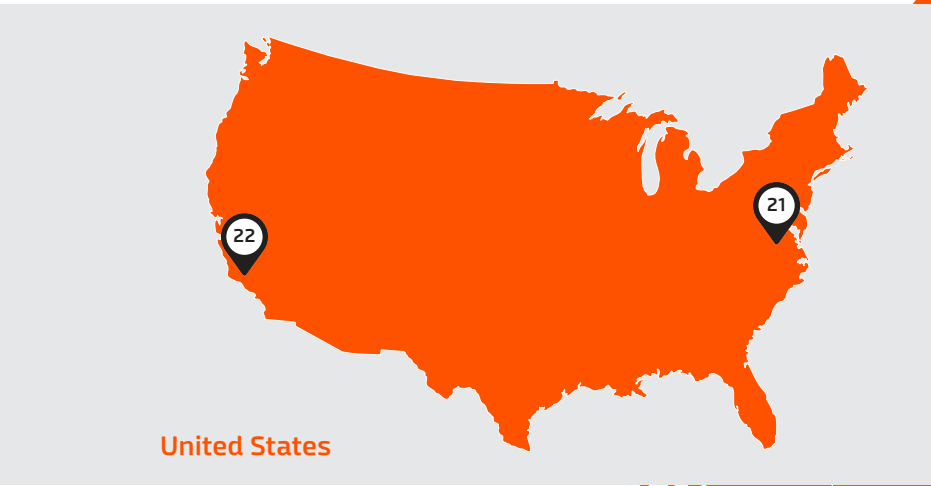



TABLE OF CONTENTS

The Orange Values	6
Our commitment to CO ₂ reduction	8
Act global produce local	10
Our effort to reuse plastic	12
Our belief in optimising costs and environmental performance	14
Load of pallets	16
Testing racking load pallets	18
Terminology	20
Material	22
Our products	28
Plastic pallets	
400 x 600 mm	30
600 x 800 mm	34
760 x 1140 mm	42
800 x 1200 mm	48
900 x 1200 mm	58
1000 x 1200 mm	64
1020 x 1220 mm	82
1100 x 1100 mm	88
1100 x 1300 mm	94
1140 x 1140 mm	102
1200 x 1200 mm	110
Specials	118
Plastic collars and covers	120
Bottleguard	122
Freezer spacers	124
Retention basin	126

A photograph of two young children playing on a colorful playground structure. The child in the foreground is a girl with long blonde hair, wearing a blue sleeveless top and red pants, smiling at the camera. The child in the background is a boy with blonde hair, wearing a light blue denim jacket over a yellow shirt and blue jeans, climbing a green vertical pole. The scene is brightly lit with warm sunlight, creating a vibrant and joyful atmosphere.

PALLETS WITH A PURPOSE

Choosing plastic pallets is a logical one, which flows from your wish for sustainability, cost efficiency and environmental considerations. Choosing Q-PALL as your partner for this is also a logical choice, which corresponds with your need for an innovative manufacturer with its own ideas.

The Orange Values

A company that, by managing the entire chain - production, distribution and sales - can offer you the technical and logistical conditions like no other that can also contribute to optimal business operations within your company.

In addition, every business also has to deal with sustainability challenges: lowering production costs, using less raw materials, and bringing sustainable products onto the market. We have brought these together in our Orange Values.



The emission of CO₂ gases contributes directly to climate change and therefore to global warming and the rise of the water level. The complex consequences of this create challenges for entire communities, agriculture and the availability of raw materials. A shared responsibility that we need to find solutions for together.

Our commitment to CO₂ reduction

Q-PALL contributes to this. Within the industry in which we operate, we promote the most efficient use of energy, in order to reduce both CO₂ emissions and costs. We focus on transport, because that is where biggest gains can be made. The transport of plastic pallets is responsible for more than 80% of the CO₂ emissions of this industry.

Our original goal for 2020 was to, in addition to a growth in volume, reduce the CO₂ emissions per transported pallet by 60%.

Today, our pallets are produced where they are needed by moving the mould to the nearest European production site. This efficient system reduces the CO₂ emissions and transportation costs to a minimum. In addition, at the end of the life cycle, the materials of our products are reused. This way, we minimise the CO₂ reduction of Q-PALL pallets in all steps of the process, from production to recycling.

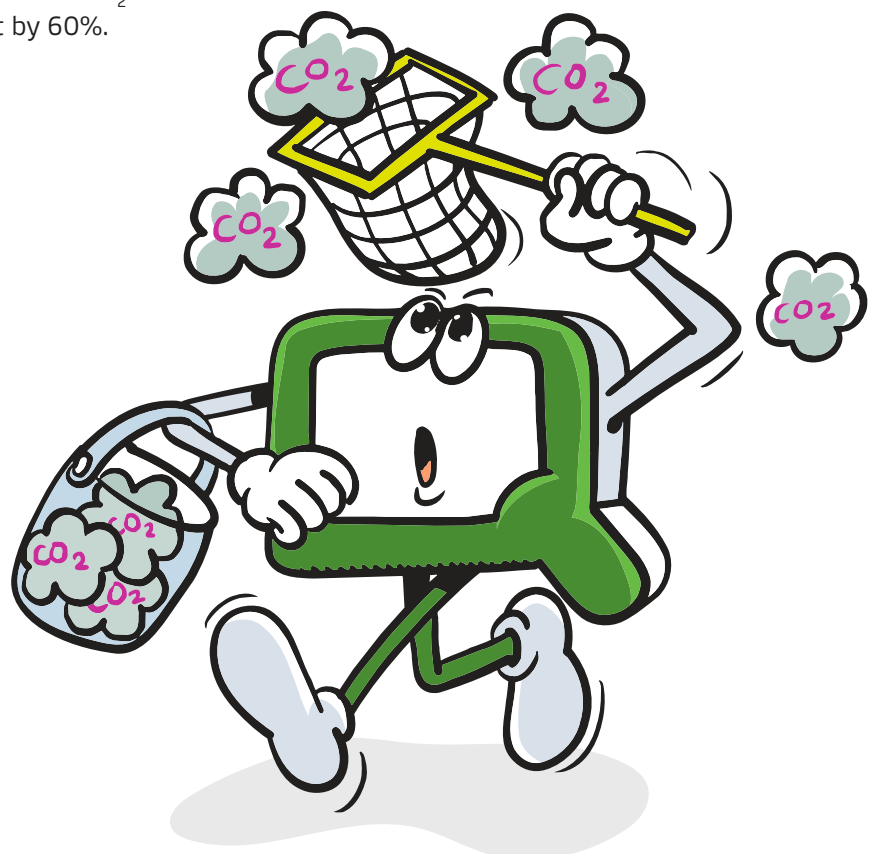

PALLETS WITH A PURPOSE



ACT

GLOBAL

PRODUCE

LOCAL

TRADITIONAL





Average savings when transporting mould instead of pallets:

-  100.000 pallets
-  CO₂ 136.700 kg 
-  100.000 km 

Q-PALL WAY





PALLETS WITH A PURPOSE

We live in a plastic era, in which more than 300 million tonnes of plastic is produced annually worldwide. 5 to 15 million tonnes of these end up in our oceans, where the 'plastic soup' is becoming a serious problem. Plastic is an important material in the current global economy. The lack of collecting, reusing, recycling, and breaking down of plastic has major consequences in terms of the environment, health, economy, and society. Doing nothing is not an option. All over the world, the realisation that we need to tackle this problem and reconsider the place of plastic and plastic packaging in our economy is growing.

Our effort to reuse plastic

At Q-PALL, we do this by recycling. When we were founded, our goal was to reuse 90% of the plastic. Today, 98% of the pallets are made from recycled materials. In addition, we commit to a better future by supporting projects that generate involvement in the plastic waste problem. We all use plastic, but can't we use less of it? And what can we do with the plastic waste to prevent it from ending up in rivers and oceans? That is why it helps if we produce less plastic and recycle more.

"We don't need to produce more plastic if we use what we already have."

Bjorn Oosterhof - Q-PALL

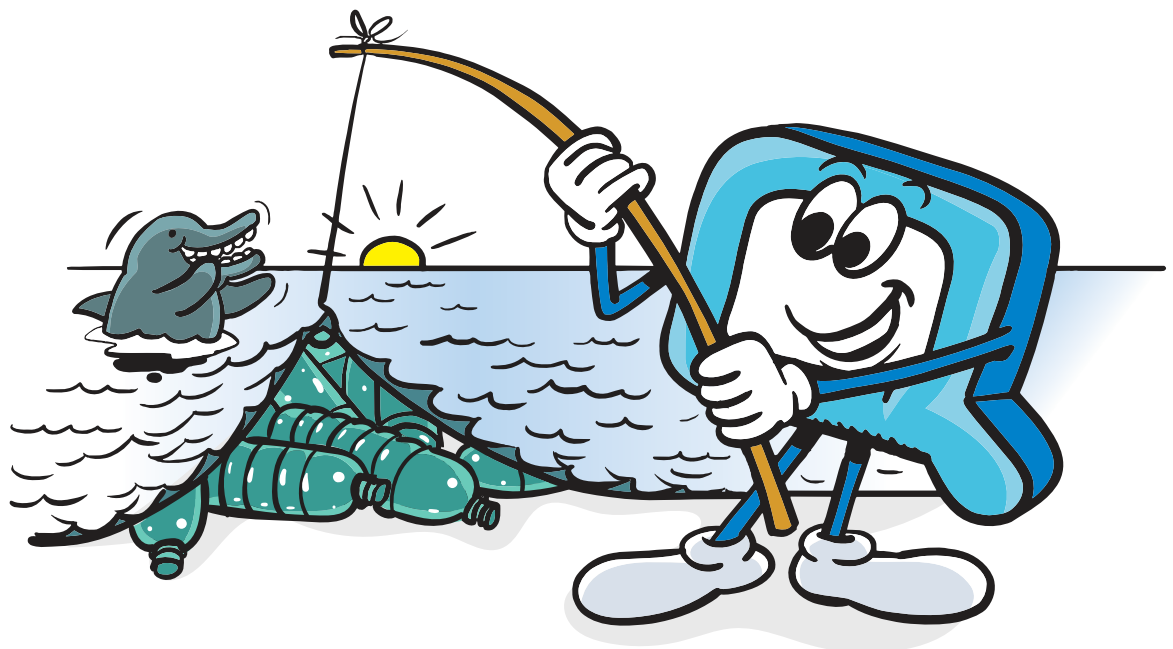

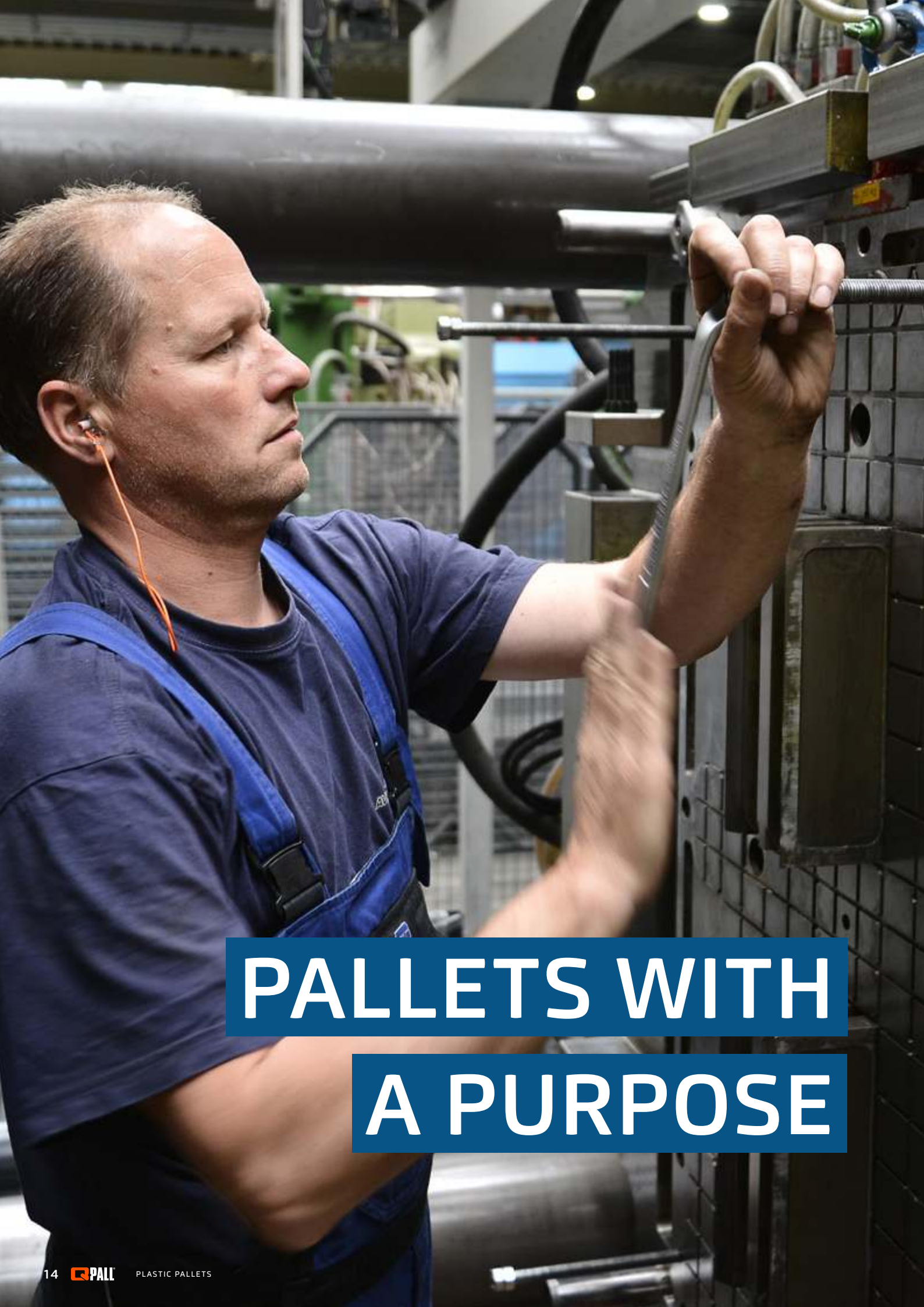

**PALLETS WITH
A PURPOSE**

Save, optimise, and reduce. Whether it is about water or energy consumption, materials, CO₂ emissions, or waste; our company has a lot to gain. In addition to the usual criteria such as price-quality ratios, the ecological footprint is becoming an ever more important issue in our customers' considerations. Environmental Product Declaration (EPD) documents are available for all types of plastic pallets. That is why we closely monitor research regarding the ecological footprint at Q-PALL. The outcomes of these form the basis for further improvement of the environmental friendliness of our products.

Our belief in optimising costs and environmental performance

Our engineers continuously work on improving and expanding our range of plastic pallets. The focus is on lightweight design, less loss of yield, and (re)using components and production scrap. The innovative concepts and products are aimed at keeping our customers at the top. That is why we often design in consultation and can meet the most specific demands with our plastic pallets. As manufacturer and supplier, Q-Pall is even one of the market leaders in the field of custom plastic pallets. The many benefits of our plastic pallets make this logistics tool better in almost every aspect.

"We keep looking for ways to minimise greenhouse gas emissions. We do this by setting the bar high in terms of energy and material efficiency through strict design objectives."

Arno Putters - Q-PALL



LOAD OF PALLETS

Racking load, static load and dynamic load what is that exactly? This question we get frequently. Below we provided you a short explanation with an illustration.

RACKING LOAD

The racking load is the maximum load a pallet in a pallet rack without shelves at a uniformly distributed load on the pallet. The pallets are tested with a equally distributed load of 25 kg bags.



* Our tests are based on the above mentioned pallet rack.

STATIC LOAD

The static load is the maximum load of a pallet as it is on a flat surface. If several pallets are stacked, the total weight determines the load on the bottom pallet.



DYNAMIC LOAD

The dynamic load is the maximum load on a pallet during transport with a forklift or pallet trailer with a uniformly distributed load on the pallet.

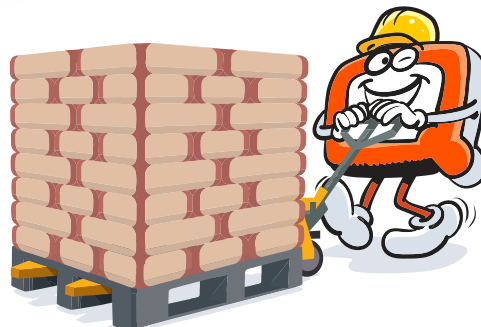

TESTING RACKING LOAD PALLETS

Test Preparation/Requirements:
the pallets are placed on two beams
(50mm) with a space between the
two beams of 100 cm. Measurements
are done on different spots of the
pallet during different times. The
pallet is loaded with 25 kg bags.

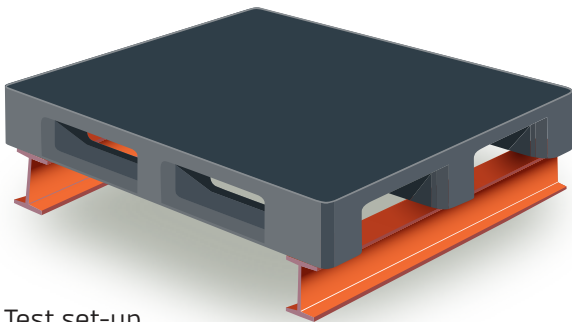

Test set-up

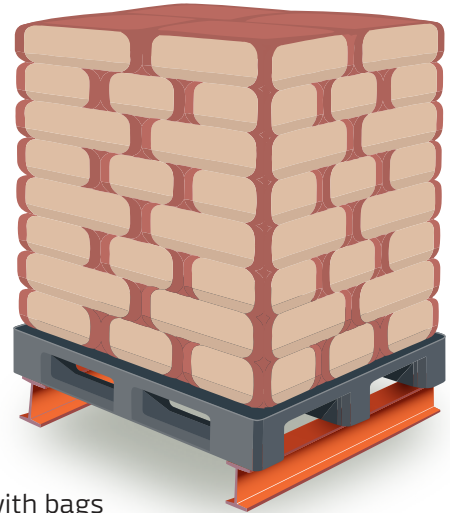

Loaded with bags
of material

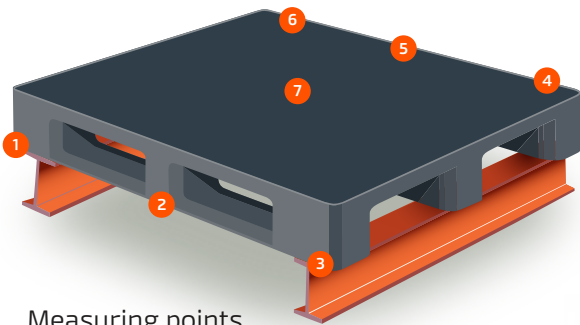

Measuring points

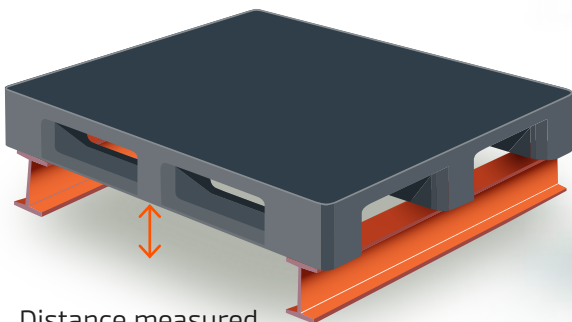

Distance measured



Pallet Rack

**“A GOOD PRODUCT
IS ONE THING,
SERVICE IS EVEN
MORE
IMPORTANT!”**

Jim Hardisty,
Dealer United Kingdom (All Pallets)

“A pallet is typically one of those products you just need and don’t want to think about too much. So we are happy to leave that to Q-PALL. In their wide range of pallets, we pretty much always find what we need. You can see they think well about their products and where to improve them. But a good product is one thing, service is even more important to us. We often need many pallets within a short amount of time. Their fast delivery and helpful ideas are the reason for us to choose Q-PALL.”



TERMINOLOGY



Rim



Without rim



Stack nock



3 Runners



4 Feet nestable



5 Runners



6 Feet nestable



6 Runners



9 Feet nestable



RAL color



Clickable runner



Foil hook



Client specific mark



Anti slip

Ole Jørgensen,
Dealer Denmark (Dansk Transport Emballage)

**“ENVIRONMENTALLY
AWARE AND
GOOD FOR
OUR WALLETS,
THE PERFECT
COMBINATION.”**

“Sustainability is important to consumers. For us as a company, it is becoming ever more important to also be able to justify the choices of our suppliers to our customers. This often results in a dilemma, because greener usually also means more expensive. Because Q-PALL has found a way that is both environmentally friendly and good for our wallets, this is the perfect combination for us. Production at the place of purchase and thus saving on transport, resulting in less CO₂ emissions and transport costs: brilliant!”



MATERIAL

ONE-WAY PALLET

BUDGET

The one-way or single-use pallets are made of the first-rate mix material PE (recycled polyethylene) and PP (polypropylene). The material is especially suitable for pallets: a quality resource for an optimal ratio between weight and strength so that is stronger and lighter.

The products are often and successfully used as export pallets. Because they are so solid, you can ship your goods safely. With these innovative pallets the smells of shipments will not be affected and the batches can be processed comfortably and without nuisance of smells.

REUSABLE PALLET

REGULAR

The reusable pallets from Mix HDPE are extremely suitable for long-term and frequent use. HDPE is known for its large strength to density ratio. Although the density of HDPE is only marginally higher than that of low-density polyethylene, HDPE has little branching, giving it stronger intermolecular forces and tensile strength than LDPE. The difference in strength exceeds the difference in density, giving HDPE a higher specific strength.

POOL PALLET

PREMIUM

All the pallets can also be made out of new material PPC (polypropylene carbonate). This plastic material is made of new resources and not of recycled materials. Because of this, PPC has a more homogenous composition, making it more solid and sustainable.



**All pallets are
100% recyclable**

Q-CARE

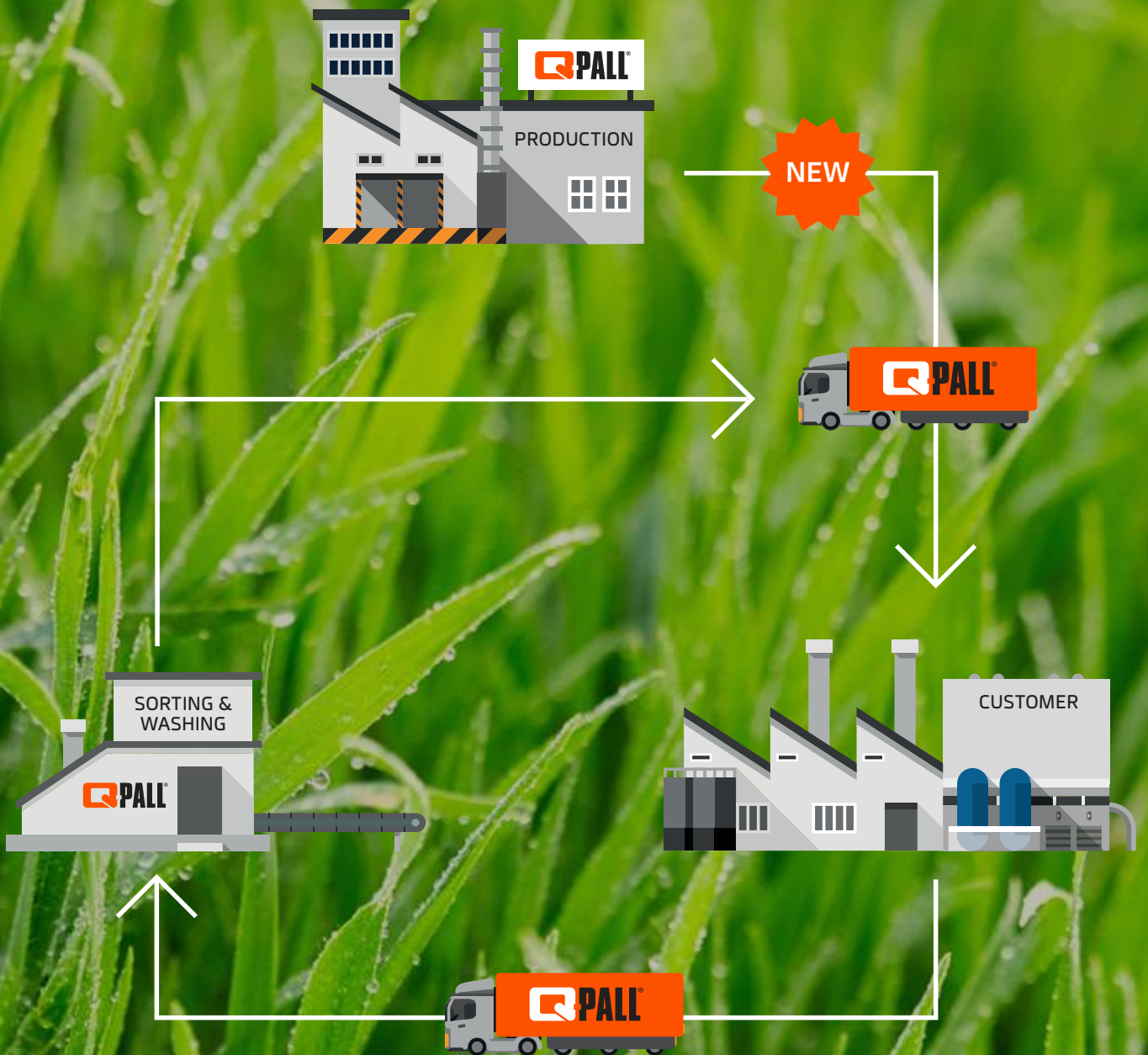



Thierry Pautonnier,
Dealer France (Bacland Pack)

**"OFFER EACH
CUSTOMER
PRECISELY
THE PRODUCTS
THAT THEY
NEED!"**

"We have been working pleasantly with Q-PALL for years. France is a major economic force, with interests spread throughout the world, and across most major industry sectors. Every industrial segment makes its own demands. That's why we look together at our clients specific challenges, and offer each one precisely the products that they need for their day-to-day work. Besides standard products, they also develop customized pallets so Q-Pall products always meet their needs."



OUR PALLET ARE TRUE ALL- ROUNDERS

The global economy facilitates a broad range of industries such as the pharmaceutical, automotive, and food industries. Transport, distribution and storage play an important role in all of those markets, just as the pallets that make it possible. As producer and supplier of plastic pallets, Q-PALL is fully aware of the specific requirements your industry sets to our products. That is why we set the bar high. We keep investing in quality, sustainability, and cost efficiency. That is why we can help you with all your needs not just today, but in the future as well.





RETAIL & SUPERMARKET

The products in this industry vary from foods to non-food products such as clothing and electronics. Retail and supermarket are the last distribution link between stores and consumers. It is important to ensure the transport runs as smoothly as possible and with as little damage as possible. Q-PALL offers tailor-made solutions for the various products: from sealable pallets to pallets that are fully suitable for automated order picking and handling systems.



The background of the page is a photograph of industrial machinery, likely a plastic pallet manufacturing machine. It features a large, light-colored metal frame, a long horizontal shaft, and various mechanical components. In the foreground, a large, dark metal mold is visible, which is used to shape plastic pallets. The mold has a grid-like structure and several rectangular openings. The overall color scheme is warm, with a strong orange and brown tint.

OUR PRODUCTS

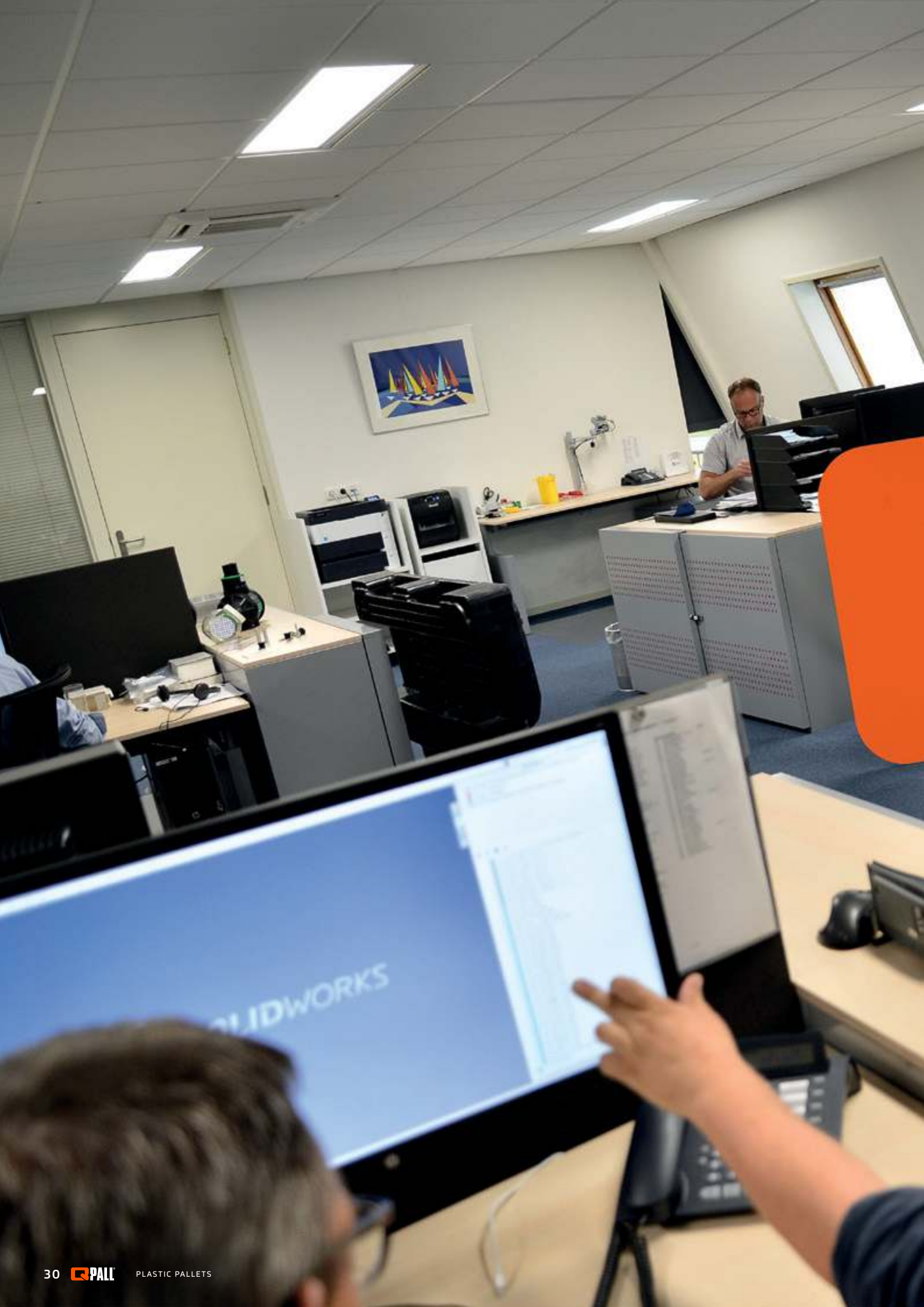

OUR PRODUCTS

400 X 600 MM



400 X 600 MM MEDIUM/HEAVY

L	Light pallet
M	Medium pallet
H	Heavy pallet
↕	Reusable pallet
→	One-way pallet



QP6040MR4F



MEDIUM

SPECIFICATIONS

ARTICLE	BOTTOM	USE	RIM	TOPDECK	DIMENSIONS			LOAD			WEIGHT
					LENGTH	WIDTH	HEIGHT	STATIC	DYNAMIC	RACKING	
QP6040MR4F	4 feet nestable	reusable	-	open	600	400	155	500	200	0	2,05

TRAILER LOADS

ARTICLE	STANDARD TRAILER*		COMBI*		20' HC CONTAINER*		40' HC CONTAINER*	
	STACK	TOTAL	STACK	TOTAL	STACK	TOTAL	STACK	TOTAL
QP6040MR4F	200	5200	200	6000	200	2000	200	4200

* Standard trailer: 13.60 x 2.44 - 2.48 x 2.65 m (L x w x h) / Combi: 7.60-7.60 x 2.45 x 3.00 m (L x w x h) / 20'HC (internal dimensions): 5.90 x 2.35 x 2.70 m (L x w x h) / 40' HC (internal dimensions): 12.00 x 2.35 x 2.70 m (L x w x h)

HEAVY

SPECIFICATIONS

ARTICLE	BOTTOM	USE	RIM	TOPDECK	DIMENSIONS			LOAD			WEIGHT
					LENGTH	WIDTH	HEIGHT	STATIC	DYNAMIC	RACKING	
QP6040HR4F	4 feet nestable	reusable	-	open	600	400	155	750	500	0	2,05

TRAILER LOADS

ARTICLE	STANDARD TRAILER*		COMBI*		20' HC CONTAINER*		40' HC CONTAINER*	
	STACK	TOTAL	STACK	TOTAL	STACK	TOTAL	STACK	TOTAL
QP6040HR4F	200	5200	200	6000	200	2000	200	4200

* Standard trailer: 13.60 x 2.44 - 2.48 x 2.65 m (L x w x h) / Combi: 7.60-7.60 x 2.45 x 3.00 m (L x w x h) / 20'HC (internal dimensions): 5.90 x 2.35 x 2.70 m (L x w x h) / 40' HC (internal dimensions): 12.00 x 2.35 x 2.70 m (L x w x h)



QP6040MR4F



QP6040MR4F

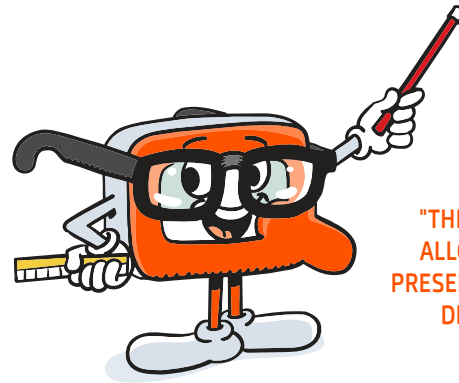

"THE DISPLAY PALLET
ALLOW RETAILERS TO
PRESENT THEIR PRODUCTS
DIRECTLY ON THE
SHOP FLOOR"

AVAILABLE OPTIONS



EDS



ANTI SLIP



PRINTING WITH LOGO AND / OR TEXT



FIRE RETARDANT



RAL COLOR



QP6040HR4F



QP6040HR4F



QP6040HR4F





BT LEVIO



OUR PRODUCTS

600 X 800 MM

600 X 800 MM LIGHT

L	Light pallet
M	Medium pallet
H	Heavy pallet
↕	Reusable pallet
→	One-way pallet



QP6080LR3RR



SPECIFICATIONS

ARTICLE	BOTTOM	USE	RIM	TOPDECK	DIMENSIONS			LOAD			WEIGHT
					LENGTH	WIDTH	HEIGHT	STATIC	DYNAMIC	RACKING	
QP6080LR3R	3 runners	reusable	-	open	800	600	145	500	350	0	2,66
QP6080LR3RR	3 runners	reusable	✓	open	800	600	145	500	350	0	2,66

TRAILER LOADS

ARTICLE	STANDARD TRAILER*		COMBI*		20' HC CONTAINER*		40' HC CONTAINER*	
	STACK	TOTAL	STACK	TOTAL	STACK	TOTAL	STACK	TOTAL
QP6080LR3R	100	3300	100	3800	100	1100	100	2500
QP6080LR3RR	100	3300	100	3800	100	1100	100	2500

* Standard trailer: 13.60 x 2.44 - 2.48 x 2.65 m (l x w x h) / Combi: 7.60-7.60 x 2.45 x 3.00 m (l x w x h) / 20'HC (internal dimensions): 5.90 x 2.35 x 2.70 m (L x w x h) / 40' HC (internal dimensions): 12.00 x 2.35 x 2.70 m (L x w x h)



QP6080LR3RR



QP6080LR3RR



600 x 800 mm

"ENGELS VERVANGEN: FOR
TRANSPORT OF SMALL
SHIPMENTS. ALSO USED TO
STORE TIRES"

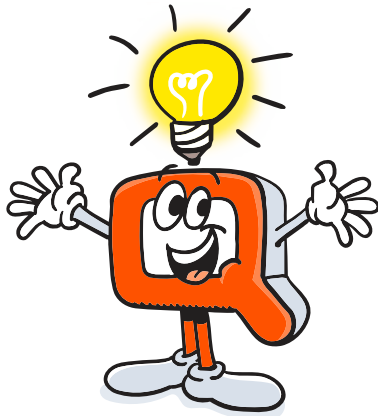

AVAILABLE OPTIONS



EDS



ANTI SLIP



PRINTING WITH LOGO AND / OR TEXT



FIRE RETARDANT



RAL COLOR



600 X 800 MM MEDIUM

L	Light pallet
M	Medium pallet
H	Heavy pallet
↕	Reusable pallet
→	One-way pallet



QP6080MR6FR



SPECIFICATIONS

ARTICLE	BOTTOM	USE	RIM	TOPDECK	DIMENSIONS			LOAD			WEIGHT
					LENGTH	WIDTH	HEIGHT	STATIC	DYNAMIC	RACKING	
QP6080MR6F	6 feet nestable	reusable	-	open	800	600	143	1000	500	0	3,14
QP6080MR6FR	6 feet nestable	reusable	✓	open	800	600	143	1000	500	0	3,14
QP6080MR3R	3 runners	reusable	-	open	800	600	143	1000	500	0	3,65
QP6080MR3RR	3 runners	reusable	✓	open	800	600	143	1000	500	0	3,65

TRAILER LOADS

ARTICLE	STANDARD TRAILER*		COMBI*		20' HC CONTAINER*		40' HC CONTAINER*	
	STACK	TOTAL	STACK	TOTAL	STACK	TOTAL	STACK	TOTAL
QP6080MR6F	80	2640	80	3040	80	880	80	2000
QP6080MR6FR	80	2640	80	3040	80	880	80	2000
QP6080MR3R	36	1188	40	1520	36	396	36	900
QP6080MR3RR	36	1188	40	1520	36	396	36	900

* Standard trailer: 13.60 x 2.44 - 2.48 x 2.65 m (l x w x h) / Combi: 7.60-7.60 x 2.45 x 3.00 m (l x w x h) / 20' HC (internal dimensions): 5.90 x 2.35 x 2.70 m (l x w x h) / 40' HC (internal dimensions): 12.00 x 2.35 x 2.70 m (l x w x h)



QP6080MR6FR

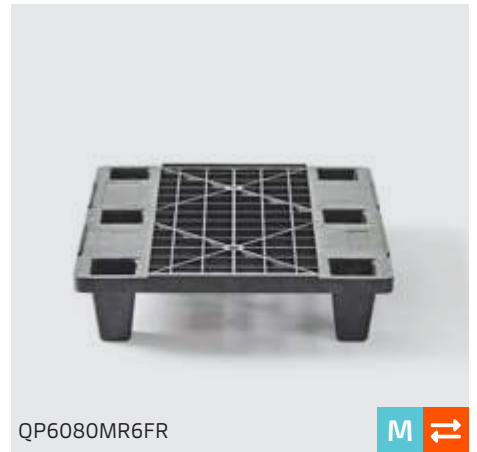

QP6080MR6FR

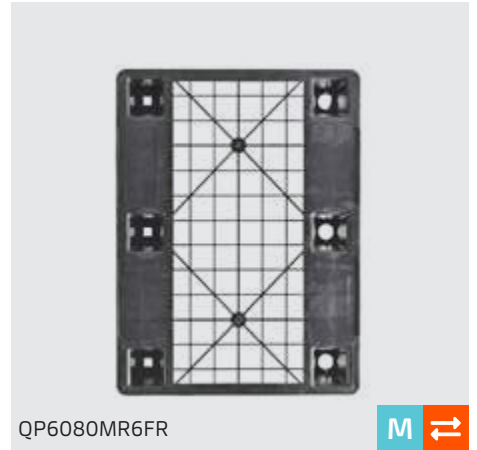

QP6080MR6FR



AVAILABLE OPTIONS



EDS



ANTI SLIP



PRINTING WITH LOGO AND / OR TEXT



FIRE RETARDANT



RAL COLOR



QP6080MR3RR



QP6080MR3RR



600 X 800 MM HEAVY

L	Light pallet
M	Medium pallet
H	Heavy pallet
↕	Reusable pallet
→	One-way pallet



QP6080HR6FR



SPECIFICATIONS

ARTICLE	BOTTOM	USE	RIM	TOPDECK	DIMENSIONS			LOAD			WEIGHT
					LENGTH	WIDTH	HEIGHT	STATIC	DYNAMIC	RACKING	
QP6080HB6F	6 feet nestable	one-way	-	open	800	600	155	1000	600	0	5,50
QP6080HB6FR	6 feet nestable	one-way	✓	open	800	600	155	1000	600	0	5,50
QP6080HR6F	6 feet nestable	reusable	-	open	800	600	155	1000	600	0	5,76
QP6080HR6FR	6 feet nestable	reusable	✓	open	800	600	155	1000	600	0	5,76

TRAILER LOADS

ARTICLE	STANDARD TRAILER*		COMBI*		20' HC CONTAINER*		40' HC CONTAINER*	
	STACK	TOTAL	STACK	TOTAL	STACK	TOTAL	STACK	TOTAL
QP6080HB6F	70	2310	80	3040	80	880	80	2000
QP6080HB6FR	70	2310	80	3040	80	880	80	2000
QP6080HR6F	70	2310	80	3040	80	880	80	2000
QP6080HR6FR	70	2310	80	3040	80	880	80	2000

* Standard trailer: 13.60 x 2.44 - 2.48 x 2.65 m (l x w x h) / Combi: 7.60-7.60 x 2.45 x 3.00 m (l x w x h) / 20' HC (internal dimensions): 5.90 x 2.35 x 2.70 m (l x w x h) / 40' HC (internal dimensions): 12.00 x 2.35 x 2.70 m (l x w x h)



QP6080HR6FR



QP6080HR6FR



AVAILABLE OPTIONS



EDS



ANTI SLIP



FIRE RETARDANT



RAL COLOR



PRINTING WITH LOGO AND / OR TEXT



QP6080HR6FR





760 x 1140 mm

OUR PRODUCTS

760 X 1140 MM



760 X 1140 MM LIGHT

L	Light pallet
M	Medium pallet
H	Heavy pallet
↕	Reusable pallet
→	One-way pallet



QP76114LB9FR



SPECIFICATIONS

ARTICLE	BOTTOM	USE	RIM	TOPDECK	DIMENSIONS			LOAD			WEIGHT
					LENGTH	WIDTH	HEIGHT	STATIC	DYNAMIC	RACKING	
QP76114LB9F	9 feet nestable	one-way	-	open	1140	760	150	2500	1000	0	4,6
QP76114LB9FR	9 feet nestable	one-way	✓	open	1140	760	150	2500	1000	0	4,6
QP76114LB9F-CD	9 feet nestable	one-way	-	closed	1140	760	150	2500	1000	0	5,7
QP76114LB9FR-CD	9 feet nestable	one-way	✓	closed	1140	760	150	2500	1000	0	5,7
QP76114LB3R-CD	3 runners	one-way	-	closed	1140	760	150	2500	1000	0	7,1
QP76114LB3RR-CD	3 runners	one-way	✓	closed	1140	760	150	2500	1000	0	7,1
QP76114LB3R	3 runners	one-way	-	open	1140	760	150	2500	1000	0	6,0
QP76114LB3RR	3 runners	one-way	✓	open	1140	760	150	2500	1000	0	6,0

TRAILER LOADS

ARTICLE	STANDARD TRAILER*		COMBI*		20' HC CONTAINER*		40' HC CONTAINER*	
	STACK	TOTAL	STACK	TOTAL	STACK	TOTAL	STACK	TOTAL
QP76114LB9F	48	1584	55	2090	48	528	48	1200
QP76114LB9FR	48	1584	55	2090	48	528	48	1200
QP76114LB9F-CD	48	1584	55	2090	48	528	48	1200
QP76114LB9FR-CD	48	1584	55	2090	48	528	48	1200
QP76114LB3R-CD	16	528	17	646	16	176	16	400
QP76114LB3RR-CD	16	528	17	646	16	176	16	400
QP76114LB3R	16	528	17	646	16	176	16	400
QP76114LB3RR	16	528	17	646	16	176	16	400

* Standard trailer: 13.60 x 2.44 - 2.48 x 2.65 m (L x w x h) / Combi: 7.60-7.60 x 2.45 x 3.00 m (L x w x h) / 20' HC (internal dimensions): 5.90 x 2.35 x 2.70 m (L x w x h) / 40' HC (internal dimensions): 12.00 x 2.35 x 2.70 m (L x w x h)



QP76114LB9FR-CD



QP76114LB9FR



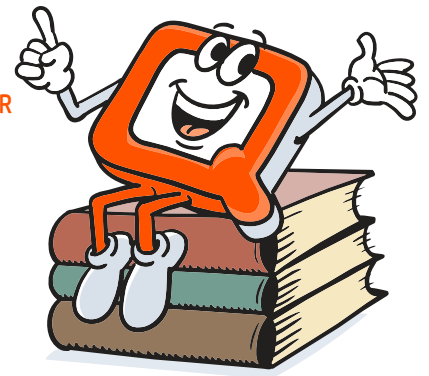

760 x 1140 mm

"ALSO KNOW AS CONTAINER
PALLET THAT USES
THE SPACE AVAILABLE
OPTIMALLY"



AVAILABLE OPTIONS

-  EDS
-  FIRE RETARDANT

-  ANTI SLIP
-  RAL COLOR

-  PRINTING WITH LOGO AND / OR TEXT



QP76114LB3RR-CD



QP76114LB3RR

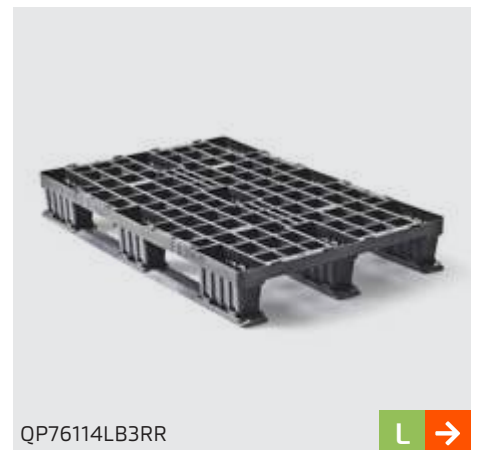

QP76114LB3RR







FOOD INDUSTRY

Food distribution is a continuous logistical process. Every day, tens of thousands of pallets are transported from production to distribution and sales centres and back again. With pallets that are used too intensively, you want reliability and durability at the lowest possible price. Unused pallets must occupy as little space as possible. Plastic pallets are a logical choice here. Light, nestable, moisture-resistant and durable.



52

49

48



800 x 1200 mm

OUR PRODUCTS

800 X 1200 MM

800 X 1200 MM LIGHT

L	Light pallet
M	Medium pallet
H	Heavy pallet
↕	Reusable pallet
→	One-way pallet



QP1208LB3RR



SPECIFICATIONS

ARTICLE	BOTTOM	USE	RIM	TOPDECK	DIMENSIONS			LOAD			WEIGHT
					LENGTH	WIDTH	HEIGHT	STATIC	DYNAMIC	RACKING	
QP1208LB9F	9 feet nestable	one-way	-	open	1200	800	150	2500	1000	0	5,12
QP1208LB9FR	9 feet nestable	one-way	✓	open	1200	800	150	2500	1000	0	5,12
QP1208LB9F-CD	9 feet nestable	one-way	-	closed	1200	800	150	2500	1000	0	6,17
QP1208LB9FR-CD	9 feet nestable	one-way	✓	closed	1200	800	150	2500	1000	0	6,17
QP1208LB3R	3 runners	one-way	-	open	1200	800	150	2500	1000	0	6,47
QP1208LB3RR	3 runners	one-way	✓	open	1200	800	150	2500	1000	0	6,47
QP1208LB3R-CD	3 runners	one-way	-	closed	1200	800	150	2500	1000	0	7,52
QP1208LB9RR-CD	3 runners	one-way	✓	closed	1200	800	150	2500	1000	0	7,52

TRAILER LOADS

ARTICLE	STANDARD TRAILER*		COMBI*		20' HC CONTAINER*		40' HC CONTAINER*	
	STACK	TOTAL	STACK	TOTAL	STACK	TOTAL	STACK	TOTAL
QP1208LB9F	48	1584	55	2090	48	528	48	1200
QP1208LB9FR	48	1584	55	2090	48	528	48	1200
QP1208LB9F-CD	48	1584	55	2090	48	528	48	1200
QP1208LB9FR-CD	48	1584	55	2090	48	528	48	1200
QP1208LB3R	16	528	17	646	16	176	16	400
QP1208LB3RR	16	528	17	646	16	176	16	400
QP1208LB3R-CD	16	528	17	646	16	176	16	400
QP1208LB9RR-CD	16	528	17	646	16	176	16	400

* Standard trailer: 13.60 x 2.44 - 2.48 x 2.65 m (l x w x h) / Combi: 7.60-7.60 x 2.45 x 3.00 m (l x w x h) / 20' HC (internal dimensions): 5.90 x 2.35 x 2.70 m (l x w x h) / 40' HC (internal dimensions): 12.00 x 2.35 x 2.70 m (l x w x h)



QP1208LB3RR





QP1208LB3RR-CD



800 x 1200 mm

AVAILABLE OPTIONS

-  EDS
-  FIRE RETARDANT

-  ANTI SLIP
-  RAL COLOR

-  PRINTING WITH LOGO AND / OR TEXT



QP1208LB9FR

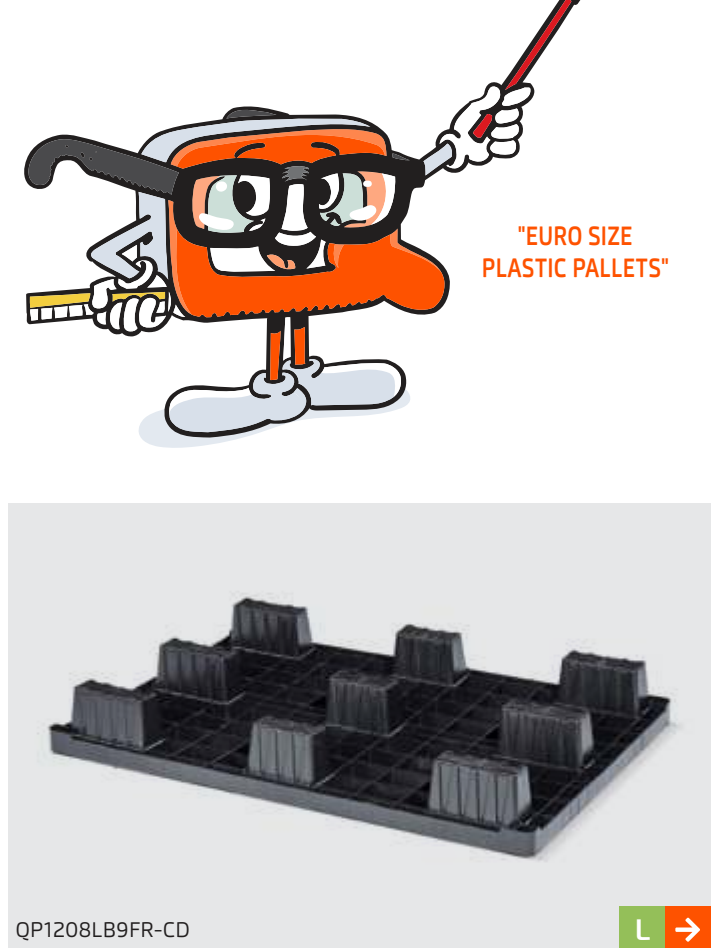

"EURO SIZE PLASTIC PALLETS"

QP1208LB9FR-CD



800 X 1200 MM MEDIUM

L	Light pallet
M	Medium pallet
H	Heavy pallet
↕	Reusable pallet
→	One-way pallet

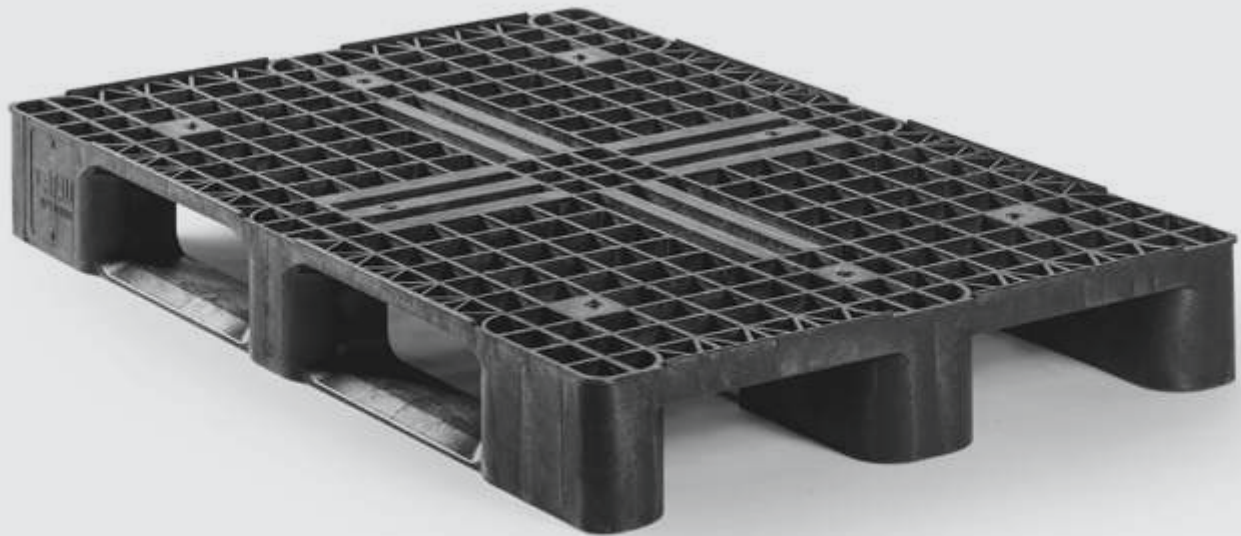

1.QP1208MR3RR



SPECIFICATIONS

ARTICLE	BOTTOM	USE	RIM	TOPDECK	DIMENSIONS			LOAD			
					LENGTH	WIDTH	HEIGHT	STATIC	DYNAMIC	RACKING	WEIGHT
1QP1208MB3R	3 runners	one-way	-	open	1200	800	145	5000	1250	600	11,66
1QP1208MB3RR	3 runners	one-way	✓	open	1200	800	145	5000	1250	600	11,66
1QP1208MR3R	3 runners	reusable	-	open	1200	800	145	5000	1250	600	11,46
1QP1208MR3RR	3 runners	reusable	✓	open	1200	800	145	5000	1250	600	11,46

TRAILER LOADS

ARTICLE	STANDARD TRAILER*		COMBI*		20' HC CONTAINER*		40' HC CONTAINER*	
	STACK	TOTAL	STACK	TOTAL	STACK	TOTAL	STACK	TOTAL
1QP1208MB3R	17	561	19	722	18	198	18	450
1QP1208MB3RR	17	561	19	722	18	198	18	450
1QP1208MR3R	17	561	19	722	18	198	18	450
1QP1208MR3RR	17	561	19	722	18	198	18	450

* Standard trailer: 13.60 x 2.44 - 2.48 x 2.65 m (l x w x h) / Combi: 7.60-7.60 x 2.45 x 3.00 m (l x w x h) / 20' HC (internal dimensions): 5.90 x 2.35 x 2.70 m (l x w x h) / 40' HC (internal dimensions): 12.00 x 2.35 x 2.70 m (l x w x h)



1.QP1208MR3RR



1.QP1208MR3RR



800 x 1200 mm

AVAILABLE OPTIONS



EDS



ANTI SLIP



PRINTING WITH LOGO AND / OR TEXT



FIRE RETARDANT



RAL COLOR



1.QP1208MR3RR - RAL



800 X 1200 MM MEDIUM

L	Light pallet
M	Medium pallet
H	Heavy pallet
↕	Reusable pallet
→	One-way pallet



2.QP1208MR3RR



SPECIFICATIONS

ARTICLE	BOTTOM	USE	RIM	TOPDECK	DIMENSIONS			LOAD			
					LENGTH	WIDTH	HEIGHT	STATIC	DYNAMIC	RACKING	WEIGHT
2QP1208MB3R	3 runners	one-way	-	open	1200	800	145	5000	1250	500	11,95
2QP1208MB3RR	3 runners	one-way	✓	open	1200	800	145	5000	1250	500	11,95
2QP1208MR3R	3 runners	reusable	-	open	1200	800	145	5000	1250	500	11,79
2QP1208MR3RR	3 runners	reusable	✓	open	1200	800	145	5000	1250	500	11,79
2QP1208MB3R-CD	3 runners	one-way	-	closed	1200	800	145	5000	1250	650	13,50
2QP1208MB3RR-CD	3 runners	one-way	✓	closed	1200	800	145	5000	1250	650	13,50
2QP1208MR3R-CD	3 runners	reusable	-	closed	1200	800	145	5000	1250	650	13,32
2QP1208MR3RR-CD	3 runners	reusable	✓	closed	1200	800	145	5000	1250	650	13,32

TRAILER LOADS

ARTICLE	STANDARD TRAILER*		COMBI*		20' HC CONTAINER*		40' HC CONTAINER*	
	STACK	TOTAL	STACK	TOTAL	STACK	TOTAL	STACK	TOTAL
2QP1208MB3R	17	561	19	722	18	198	18	450
2QP1208MB3RR	17	561	19	722	18	198	18	450
2QP1208MR3R	17	561	19	722	18	198	18	450
2QP1208MR3RR	17	561	19	722	18	198	18	450
2QP1208MB3R-CD	17	561	19	722	18	198	18	450
2QP1208MB3RR-CD	17	561	19	722	18	198	18	450
2QP1208MR3R-CD	17	561	19	722	18	198	18	450
2QP1208MR3RR-CD	17	561	19	722	18	198	18	450

* Standard trailer: 13.60 x 2.44 - 2.48 x 2.65 m (l x w x h) / Combi: 7.60-7.60 x 2.45 x 3.00 m (l x w x h) / 20' HC (internal dimensions): 5.90 x 2.35 x 2.70 m (l x w x h) / 40' HC (internal dimensions): 12.00 x 2.35 x 2.70 m (l x w x h)



800 x 1200 mm

AVAILABLE OPTIONS



EDS



ANTI SLIP



PRINTING WITH LOGO AND / OR TEXT



FIRE RETARDANT



RAL COLOR



800 X 1200 MM HEAVY

L	Light pallet
M	Medium pallet
H	Heavy pallet
↕	Reusable pallet
→	One-way pallet



QP1208HR5RR



SPECIFICATIONS

ARTICLE	BOTTOM	USE	RIM	TOPDECK	DIMENSIONS			LOAD			
					LENGTH	WIDTH	HEIGHT	STATIC	DYNAMIC	RACKING	WEIGHT
QP1208HB3R	3 runners	one-way	-	open	1200	800	156	7500	1750	1000	16,41
QP1208HB3RR	3 runners	one-way	✓	open	1200	800	156	7500	1750	1000	16,41
QP1208HR3R	3 runners	reusable	-	open	1200	800	156	7500	1750	1000	16,35
QP1208HR3RR	3 runners	reusable	✓	open	1200	800	156	7500	1750	1000	16,35
QP1208HB5R	5 runners	one-way	-	open	1200	800	156	7500	1750	1000	17,15
QP1208HB5RR	5 runners	one-way	✓	open	1200	800	156	7500	1750	1000	17,15
QP1208HR5R	5 runners	reusable	-	open	1200	800	156	7500	1750	1000	17,15
QP1208HR5RR	5 runners	reusable	✓	open	1200	800	156	7500	1750	1000	17,15
EUROPAL800R	3 runners	reusable	-	closed	1200	800	150	5000	1500	750	23,00
EUROPAL800RR	3 runners	reusable	✓	closed	1200	800	150	5000	1500	750	23,00
QPH1208HP3RR-CDG	3 runners	reusable	✓	closed	1200	800	160	7500	1500	1000	18,00
QPH1208HP3RR-CDG*	3 runners	reusable	✓	closed	1200	800	160	7500	1500	1750	18,00

* With optional reinforcement profiles

TRAILER LOADS

ARTICLE	STANDARD TRAILER*		COMBI*		20' HC CONTAINER*		40' HC CONTAINER*	
	STACK	TOTAL	STACK	TOTAL	STACK	TOTAL	STACK	TOTAL
QP1208HB3R	15	495	18	684	17	187	17	425
QP1208HB3RR	15	495	18	684	17	187	17	425
QP1208HR3R	15	495	18	684	17	187	17	425
QP1208HR3RR	15	495	18	684	17	187	17	425
QP1208HB5R	15	495	18	684	17	187	17	425
QP1208HB5RR	15	495	18	684	17	187	17	425
QP1208HR5R	15	495	18	684	17	187	17	425
QP1208HR5RR	15	495	18	684	17	187	17	425
EUROPAL800R	23	598	23	690	18	198	18	450
EUROPAL800RR	23	598	23	690	18	198	18	450
QPH1208HP3RR-CDG	15	495	18	684	18	198	18	450
QPH1208HP3RR-CDG*	15	495	18	684	18	198	18	450

* Standard trailer: 13.60 x 2.44 - 2.48 x 2.65 m (L x w x h) / Combi: 7.60-7.60 x 2.45 x 3.00 m (L x w x h) / 20' HC (internal dimensions): 5.90 x 2.35 x 2.70 m (L x w x h) / 40' HC (internal dimensions): 12.00 x 2.35 x 2.70 m (L x w x h)



QP1208HR3RR



QP1208HR3RR



QP1208HR5RR



800 x 1200 mm

AVAILABLE OPTIONS



EDS



ANTI SLIP



PRINTING WITH LOGO AND / OR TEXT



FIRE RETARDANT



RAL COLOR



EUROPAL800RR



EUROPAL800RR



QPH1208HP3RR-CDG



QPH1208HP3RR-CDG





900 x 1200 mm

OUR PRODUCTS

900 X 1200 MM

900 X 1200 MM HEAVY

L	Light pallet
M	Medium pallet
H	Heavy pallet
↕	Reusable pallet
→	One-way pallet



QP1209HR3R



SPECIFICATIONS

ARTICLE	BOTTOM	USE	RIM	TOPDECK	DIMENSIONS			LOAD			WEIGHT
					LENGTH	WIDTH	HEIGHT	STATIC	DYNAMIC	RACKING	
QP1209HB3R	3 runners	one-way	-	open	1200	900	156	7500	1500	1000	17,90
QP1209HB3RR	3 runners	one-way	✓	open	1200	900	156	7500	1500	1000	17,90
QP1209HR3R	3 runners	reusable	-	open	1200	900	156	7500	1500	1000	17,90
QP1209HR3RR	3 runners	reusable	✓	open	1200	900	156	7500	1500	1000	17,90
QP1209HB5R	5 runners	one-way	-	open	1200	900	156	7500	1500	1000	18,90
QP1209HB5RR	5 runners	one-way	✓	open	1200	900	156	7500	1500	1000	18,90
QP1209HR5R	5 runners	reusable	-	open	1200	900	156	7500	1500	1000	18,90
QP1209HR5RR	5 runners	reusable	✓	open	1200	900	156	7500	1500	1000	18,90

TRAILER LOADS

ARTICLE	STANDARD TRAILER*		COMBI*		20' HC CONTAINER*		40' HC CONTAINER*	
	STACK	TOTAL	STACK	TOTAL	STACK	TOTAL	STACK	TOTAL
QP1209HB3R	15	450	18	540	17	136	17	340
QP1209HB3RR	15	450	18	540	17	136	17	340
QP1209HR3R	15	450	18	540	17	136	17	340
QP1209HR3RR	15	450	18	540	17	136	17	340
QP1209HB5R	15	450	18	540	17	136	17	340
QP1209HB5RR	15	450	18	540	17	136	17	340
QP1209HR5R	15	450	18	540	17	136	17	340
QP1209HR5RR	15	450	18	540	17	136	17	340

* Standard trailer: 13.60 x 2.44 - 2.48 x 2.65 m (l x w x h) / Combi: 7.60-7.60 x 2.45 x 3.00 m (l x w x h) / 20' HC (internal dimensions): 5.90 x 2.35 x 2.70 m (l x w x h) / 40' HC (internal dimensions): 12.00 x 2.35 x 2.70 m (l x w x h)



QP1209HR3R



QP1209HR3R - Without rim



900 x 1200 mm

AVAILABLE OPTIONS

- EDS
- FIRE RETARDANT

- ANTI SLIP
- RAL COLOR

- PRINTING WITH LOGO AND / OR TEXT

"THIS PALLET ALLOWS EGG PRODUCERS TO PROCESS AND PALLETISE THEIR EGGS WITH EASE AND AT A SPEED"



QP1209HR5RR



QP1209HR5RR



QP1209HR5RR







MEAT

PROCESSING

INDUSTRY

Meat is a perishable product. That is why the strict HACCP guidelines for food safety apply to all steps of the production and distribution process. It is important for pallets to seamlessly fit into the hygienic production or packaging processes of this industry. This also means they need to be delivered on time. Because pallets are not always returned in case of larger distances, the price is very important. The standardised H1 hygiene pallet is a good choice, but there are other options as well. Q-PALL provides cost efficient, reliable pallets that meet the strict hygiene requirements of the meat processing industry.





1000 x 1200 mm

OUR PRODUCTS

1000 X 1200 MM

1000 X 1200 MM LIGHT

L	Light pallet
M	Medium pallet
H	Heavy pallet
↕	Reusable pallet
→	One-way pallet



QP1210LB3R



SPECIFICATIONS

ARTICLE	BOTTOM	USE	RIM	TOPDECK	DIMENSIONS			LOAD			WEIGHT
					LENGTH	WIDTH	HEIGHT	STATIC	DYNAMIC	RACKING	
QP1210LB9F	9 feet nestable	one-way	-	open	1200	1000	150	2500	1000	0	7,0
QP1210LB9FR	9 feet nestable	one-way	✓	open	1200	1000	150	2500	1000	0	7,0
QP1210LB3R	3 runners	one-way	-	open	1200	1000	160	2500	1000	0	8,4
QP1210LB3RR	3 runners	one-way	✓	open	1200	1000	160	2500	1000	0	8,4
QP1210LB9F-CD	9 feet nestable	one-way	-	closed	1200	1000	150	2500	1000	0	8,2
QP1210LB9FR-CD	9 feet nestable	one-way	✓	closed	1200	1000	150	2500	1000	0	8,2
QP1210LB3R-CD	3 runners	one-way	-	closed	1200	1000	150	2500	1000	0	9,6
QP1210LB3RR-CD	3 runners	one-way	✓	closed	1200	1000	150	2500	1000	0	9,6

TRAILER LOADS

ARTICLE	STANDARD TRAILER*		COMBI*		20' HC CONTAINER*		40' HC CONTAINER*	
	STACK	TOTAL	STACK	TOTAL	STACK	TOTAL	STACK	TOTAL
QP1210LB9F	48	1248	55	1650	48	480	48	1008
QP1210LB9FR	48	1248	55	1650	48	480	48	1008
QP1210LB3R	16	416	17	510	16	160	16	336
QP1210LB3RR	16	416	17	510	16	160	16	336
QP1210LB9F-CD	48	1248	55	1650	48	480	48	1008
QP1210LB9FR-CD	48	1248	55	1650	48	480	48	1008
QP1210LB3R-CD	16	416	17	510	16	160	16	336
QP1210LB3RR-CD	16	416	17	510	16	160	16	336

* Standard trailer: 13.60 x 2.44 - 2.48 x 2.65 m (l x w x h) / Combi: 7.60-7.60 x 2.45 x 3.00 m (l x w x h) / 20'HC (internal dimensions): 5.90 x 2.35 x 2.70 m (l x w x h) / 40' HC (internal dimensions): 12.00 x 2.35 x 2.70 m (l x w x h)



AVAILABLE OPTIONS

- EDS
- FIRE RETARDANT

- ANTI SLIP
- RAL COLOR

- PRINTING WITH LOGO AND / OR TEXT

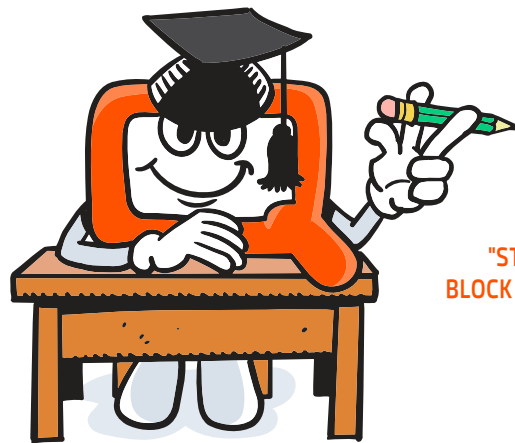

1000 x 1200 mm

1000 X 1200 MM MEDIUM

L	Light pallet
M	Medium pallet
H	Heavy pallet
↕	Reusable pallet
→	One-way pallet



1.QP1210MR3RR



SPECIFICATIONS

ARTICLE	BOTTOM	USE	RIM	TOPDECK	DIMENSIONS			LOAD			WEIGHT
					LENGTH	WIDTH	HEIGHT	STATIC	DYNAMIC	RACKING	
1QP1210MB3R	3 runners	one-way	-	open	1200	1000	165	6000	1250	350	13,97
1QP1210MB3RR	3 runners	one-way	✓	open	1200	1000	165	6000	1250	350	13,97
1QP1210MB6R	6 runners	one-way	-	open	1200	1000	165	6000	1250	800	15,95
1QP1210MB6RR	6 runners	one-way	✓	open	1200	1000	165	6000	1250	800	15,95
1QP1210MR3R	3 runners	reusable	-	open	1200	1000	165	6000	1250	350	14,95
1QP1210MR3RR	3 runners	reusable	✓	open	1200	1000	165	6000	1250	350	14,95
1QP1210MR6R	6 runners	reusable	-	open	1200	1000	165	6000	1250	800	15,90
1QP1210MR6RR	6 runners	reusable	✓	open	1200	1000	165	6000	1250	800	15,90

TRAILER LOADS

ARTICLE	STANDARD TRAILER*		COMBI*		20' HC CONTAINER*		40' HC CONTAINER*	
	STACK	TOTAL	STACK	TOTAL	STACK	TOTAL	STACK	TOTAL
1QP1210MB3R	15	390	17	510	16	160	16	336
1QP1210MB3RR	15	390	17	510	16	160	16	336
1QP1210MB6R	15	390	17	510	16	160	16	336
1QP1210MB6RR	15	390	17	510	16	160	16	336
1QP1210MR3R	15	390	17	510	16	160	16	336
1QP1210MR3RR	15	390	17	510	16	160	16	336
1QP1210MR6R	15	390	17	510	16	160	16	336
1QP1210MR6RR	15	390	17	510	16	160	16	336

* Standard trailer: 13.60 x 2.44 - 2.48 x 2.65 m (l x w x h) / Combi: 7.60-7.60 x 2.45 x 3.00 m (l x w x h) / 20' HC (internal dimensions): 5.90 x 2.35 x 2.70 m (l x w x h) / 40' HC (internal dimensions): 12.00 x 2.35 x 2.70 m (l x w x h)



1.QP1210MR6RR



AVAILABLE OPTIONS



EDS



ANTI SLIP



PRINTING WITH LOGO AND / OR TEXT



FIRE RETARDANT



RAL COLOR

1000 x 1200 mm



1.QP1210MR3RR



1.QP1210MR6RR



1000 X 1200 MM MEDIUM

L	Light pallet
M	Medium pallet
H	Heavy pallet
↕	Reusable pallet
→	One-way pallet

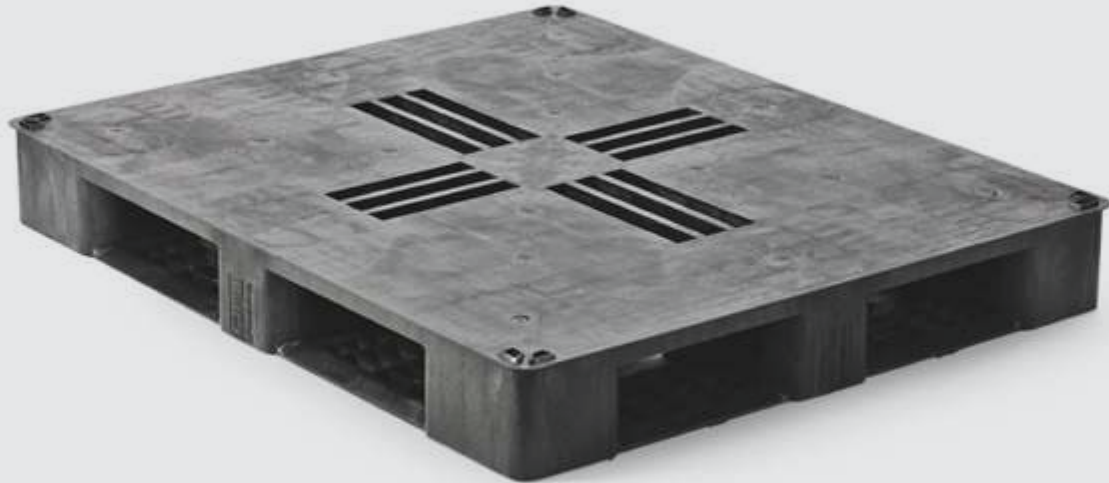

QP1210MR6R-ASCD



SPECIFICATIONS

ARTICLE	BOTTOM	USE	RIM	TOPDECK	DIMENSIONS			LOAD			
					LENGTH	WIDTH	HEIGHT	STATIC	DYNAMIC	RACKING	WEIGHT
2QP1210MB3R	3 runners	one-way	-	open	1200	1000	150	6000	1250	350	15,54
2QP1210MB3RR	3 runners	one-way	✓	open	1200	1000	150	6000	1250	350	15,54
2QP1210MB3R-CD	3 runners	one-way	-	closed	1200	1000	150	6000	1250	1000	17,75
2QP1210MB3RR-CD	3 runners	one-way	✓	closed	1200	1000	150	6000	1250	1000	17,75
2QP1210MB6R	6 runners	one-way	-	open	1200	1000	150	6000	1250	800	16,10
2QP1210MB6RR	6 runners	one-way	✓	open	1200	1000	150	6000	1250	800	16,10
2QP1210MB6R-CD	6 runners	one-way	-	closed	1200	1000	150	6000	1250	1000	16,90
2QP1210MB6RR-CD	6 runners	one-way	✓	closed	1200	1000	150	6000	1250	1000	16,90

ARTICLE	BOTTOM	USE	RIM	TOPDECK	DIMENSIONS			LOAD			
					LENGTH	WIDTH	HEIGHT	STATIC	DYNAMIC	RACKING	WEIGHT
2QP1210MR3R	3 runners	reusable	-	open	1200	1000	150	6000	1250	350	15,33
2QP1210MR3RR	3 runners	reusable	✓	open	1200	1000	150	6000	1250	350	15,33
2QP1210MR3R-CD	3 runners	reusable	-	closed	1200	1000	150	6000	1250	1000	17,75
2QP1210MR3RR-CD	3 runners	reusable	✓	closed	1200	1000	150	6000	1250	1000	17,75
2QP1210MR6R	6 runners	reusable	-	open	1200	1000	150	6000	1250	800	16,10
2QP1210MR6RR	6 runners	reusable	✓	open	1200	1000	150	6000	1250	800	16,10
2QP1210MR6R-CD	6 runners	reusable	-	closed	1200	1000	150	6000	1250	1000	17,54
2QP1210MR6RR-CD	6 runners	reusable	✓	closed	1200	1000	150	6000	1250	1000	17,54



2.QP1210MR3RR-CD



2.QP1210MR3RR-CD



2.QP1210MR6RR-CD



AVAILABLE OPTIONS



EDS



ANTI SLIP



PRINTING WITH LOGO AND / OR TEXT



1000 x 1200 mm



2.QP1210MR3RR



2.QP1210MR6RR



TRAILER LOADS

ARTICLE	STANDARD TRAILER*		COMBI*		20' HC CONTAINER*		40' HC CONTAINER*	
	STACK	TOTAL	STACK	TOTAL	STACK	TOTAL	STACK	TOTAL
2QP1210Mx3R	17	442	19	570	17	170	17	357
2QP1210Mx3RR	17	442	19	570	17	170	17	357
2QP1210Mx3R-CD	17	442	19	570	17	170	17	357
2QP1210Mx3RR-CD	17	442	19	570	17	170	17	357
2QP1210Mx6R	17	442	19	570	17	170	17	357
2QP1210Mx6RR	17	442	19	570	17	170	17	357
2QP1210Mx6R-CD	17	442	19	570	17	170	17	357
2QP1210Mx6RR-CD	17	442	19	570	17	170	17	357

* Standard trailer: 13.60 x 2.44 - 2.48 x 2.65 m (L x w x h) / Combi: 7.60-7.60 x 2.45 x 3.00 m (L x w x h) / 20'HC (internal dimensions): 5.90 x 2.35 x 2.70 m (L x w x h) / 40' HC (internal dimensions): 12.00 x 2.35 x 2.70 m (L x w x h)

1000 X 1200 MM HEAVY

L	Light pallet
M	Medium pallet
H	Heavy pallet
↕	Reusable pallet
→	One-way pallet



QP1210HR3RR



SPECIFICATIONS

ARTICLE	BOTTOM	USE	RIM	TOPDECK	DIMENSIONS			LOAD			
					LENGTH	WIDTH	HEIGHT	STATIC	DYNAMIC	RACKING	WEIGHT
QP1210HB3R	3 runners	one-way	-	open	1200	1000	160	7500	1500	1250	19,73
QP1210HB3RR	3 runners	one-way	✓	open	1200	1000	160	7500	1500	1250	19,73
QP1210HB5R	5 runners	one-way	-	open	1200	1000	160	7500	1500	1375	20,95
QP1210HB5RR	5 runners	one-way	✓	open	1200	1000	160	7500	1500	1375	20,95
QP1210HR3R	3 runners	reusable	-	open	1200	1000	160	7500	1500	1250	19,36
QP1210HR3RR	3 runners	reusable	✓	open	1200	1000	160	7500	1500	1250	19,36
QP1210HR5R	5 runners	reusable	-	open	1200	1000	160	7500	1500	1375	20,93
QP1210HR5RR	5 runners	reusable	✓	open	1200	1000	160	7500	1500	1375	20,93

TRAILER LOADS

ARTICLE	STANDARD TRAILER*		COMBI*		20' HC CONTAINER*		40' HC CONTAINER*	
	STACK	TOTAL	STACK	TOTAL	STACK	TOTAL	STACK	TOTAL
QP1210HB3R	15	390	17	510	16	160	16	336
QP1210HB3RR	15	390	17	510	16	160	16	336
QP1210HB5R	15	390	17	510	16	160	16	336
QP1210HB5RR	15	390	17	510	16	160	16	336
QP1210HR3R	15	390	17	510	16	160	16	336
QP1210HR3RR	15	390	17	510	16	160	16	336
QP1210HR5R	15	390	17	510	16	160	16	336
QP1210HR5RR	15	390	17	510	16	160	16	336

* Standard trailer: 13.60 x 2.44 - 2.48 x 2.65 m (l x w x h) / Combi: 7.60-7.60 x 2.45 x 3.00 m (l x w x h) / 20' HC (internal dimensions): 5.90 x 2.35 x 2.70 m (l x w x h) / 40' HC (internal dimensions): 12.00 x 2.35 x 2.70 m (l x w x h)



QP1210HR5RR



QP1210HR3RR



QP1210HR5RR



AVAILABLE OPTIONS



ESD



ANTI SLIP



PRINTING WITH LOGO AND / OR TEXT



FIRE RETARDANT



RAL COLOR



QP1210HR5RR



22 mm rims

1000 x 1200 mm

1000 X 1200 MM HEAVY

L	Light pallet
M	Medium pallet
H	Heavy pallet
↕	Reusable pallet
→	One-way pallet



QP1210HR3RR-CD



SPECIFICATIONS

ARTICLE	BOTTOM	USE	RIM	TOPDECK	DIMENSIONS			LOAD			
					LENGTH	WIDTH	HEIGHT	STATIC	DYNAMIC	RACKING	WEIGHT
2QP1210HB3R	3 runners	one-way	-	open	1200	1000	158	7500	1500	1250	20,48
2QP1210HB3RR	3 runners	one-way	✓	open	1200	1000	158	7500	1500	1250	20,48
2QP1210HB3R-CD	3 runners	one-way	-	closed	1200	1000	158	7500	1500	1375	22,05
2QP1210HB3RR-CD	3 runners	one-way	✓	closed	1200	1000	158	7500	1500	1375	22,05
2QP1210HR3R	3 runners	reusable	-	open	1200	1000	158	7500	1500	1250	20,45
2QP1210HR3RR	3 runners	reusable	✓	open	1200	1000	158	7500	1500	1250	20,45
2QP1210HR3R-CD	3 runners	reusable	-	closed	1200	1000	158	7500	1500	1375	22,05
2QP1210HR3RR-CD	3 runners	reusable	✓	closed	1200	1000	158	7500	1500	1375	22,05

TRAILER LOADS

ARTICLE	STANDARD TRAILER*		COMBI*		20' HC CONTAINER*		40' HC CONTAINER*	
	STACK	TOTAL	STACK	TOTAL	STACK	TOTAL	STACK	TOTAL
2QP1210HB3R	16	416	18	540	16	160	16	336
2QP1210HB3RR	16	416	18	540	16	160	16	336
QP1210HB3R-CD	16	416	18	540	16	160	16	336
QP1210HB3RR-CD	16	416	18	540	16	160	16	336
2QP1210HR3R	16	416	18	540	16	160	16	336
2QP1210HR3RR	16	416	18	540	16	160	16	336
QP1210HR3R-CD	16	416	18	540	16	160	16	336
QP1210HR3RR-CD	16	416	18	540	16	160	16	336

* Standard trailer: 13.60 x 2.44 - 2.48 x 2.65 m (l x w x h) / Combi: 7.60-7.60 x 2.45 x 3.00 m (l x w x h) / 20' HC (internal dimensions): 5.90 x 2.35 x 2.70 m (l x w x h) / 40' HC (internal dimensions): 12.00 x 2.35 x 2.70 m (l x w x h)



2.QP1210HR3RR



AVAILABLE OPTIONS



EDS



ANTI SLIP



PRINTING WITH LOGO AND / OR TEXT



FIRE RETARDANT



RAL COLOR

1000 x 1200 mm



QP1210HR3RR-CD



1000 X 1200 MM HEAVY

L	Light pallet
M	Medium pallet
H	Heavy pallet
↕	Reusable pallet
→	One-way pallet

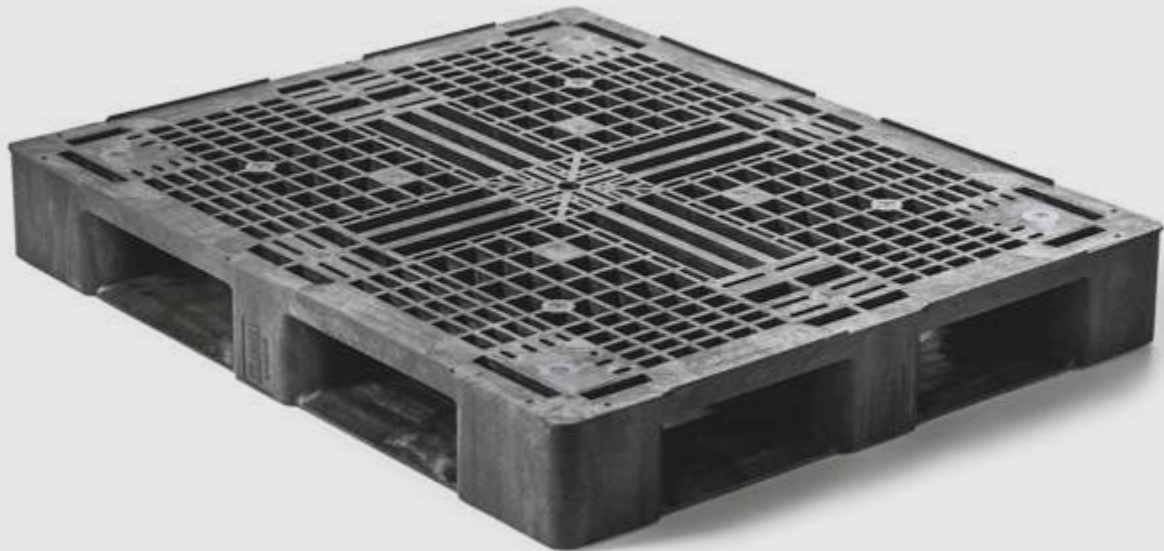

QP1210HR6RR



SPECIFICATIONS

ARTICLE	BOTTOM	USE	RIM	TOPDECK	DIMENSIONS			LOAD			
					LENGTH	WIDTH	HEIGHT	STATIC	DYNAMIC	RACKING	WEIGHT
QP1210HB6R	6 runners	one-way	-	open	1200	1000	158	7500	1500	1250	21,92
QP1210HB6RR	6 runners	one-way	✓	open	1200	1000	158	7500	1500	1250	21,92
QP1210HB6R-CD	6 runners	one-way	-	closed	1200	1000	158	7500	1500	1375	22,65
QP1210HB6RR-CD	6 runners	one-way	✓	closed	1200	1000	158	7500	1500	1375	22,65
QP1210HR6R	6 runners	reusable	-	open	1200	1000	158	7500	1500	1250	21,00
QP1210HR6RR	6 runners	reusable	✓	open	1200	1000	158	7500	1500	1250	21,00
QP1210HR6R-CD	6 runners	reusable	-	closed	1200	1000	158	7500	1500	1375	22,60
QP1210HR6RR-CD	6 runners	reusable	✓	closed	1200	1000	158	7500	1500	1375	22,60

TRAILER LOADS

ARTICLE	STANDARD TRAILER*		COMBI*		20' HC CONTAINER*		40' HC CONTAINER*	
	STACK	TOTAL	STACK	TOTAL	STACK	TOTAL	STACK	TOTAL
QP1210HB6R	16	416	18	540	16	160	16	336
QP1210HB6RR	16	416	18	540	16	160	16	336
QP1210HB6R-CD	16	416	18	540	16	160	16	336
QP1210HB6RR-CD	16	416	18	540	16	160	16	336
QP1210HR6R	16	416	18	540	16	160	16	336
QP1210HR6RR	16	416	18	540	16	160	16	336
QP1210HR6R-CD	16	416	18	540	16	160	16	336
QP1210HR6RR-CD	16	416	18	540	16	160	16	336

* Standard trailer: 13.60 x 2.44 - 2.48 x 2.65 m (l x w x h) / Combi: 7.60-7.60 x 2.45 x 3.00 m (l x w x h) / 20' HC (internal dimensions): 5.90 x 2.35 x 2.70 m (l x w x h) / 40' HC (internal dimensions): 12.00 x 2.35 x 2.70 m (l x w x h)



QP1210HR6R-ASCD



AVAILABLE OPTIONS

- EDS
- FIRE RETARDANT

- ANTI SLIP
- RAL COLOR

- PRINTING WITH LOGO AND / OR TEXT

1000 x 1200 mm



QP1210HR6RR



QP1210HR6R-ASCD



1000 X 1200 MM HEAVY

L	Light pallet
M	Medium pallet
H	Heavy pallet
↕	Reusable pallet
→	One-way pallet



RECPAL1210RR



SPECIFICATIONS

ARTICLE	BOTTOM	USE	RIM	TOPDECK	DIMENSIONS			LOAD			
					LENGTH	WIDTH	HEIGHT	STATIC	DYNAMIC	RACKING	WEIGHT
Recypal1210R	3 runners	reusable	-	closed	1200	1000	150	5000	1500	900	28,0
Recypal1210RR	3 runners	reusable	✓	closed	1200	1000	150	5000	1500	900	28,0
QPH1210HP3RR-CDG	3 runners	reusable	✓	closed	1200	1000	160	7500	1500	1250	21,5
QPH1210HP3RR-CDB	3 runners	reusable	✓	closed	1200	1000	160	7500	1500	1250	21,5
QPH1210HP3RR-CDG*	3 runners	reusable	✓	closed	1200	1000	160	7500	1500	2000	21,5
QPH1210HP3RR-CDB*	3 runners	reusable	✓	closed	1200	1000	160	7500	1500	2000	21,5
QPH1210HP5RR-CDB	5 runners	reusable	✓	closed	1200	1000	160	7500	1500	1250	22,5
QPH1210HP5RR-CDG	5 runners	reusable	✓	closed	1200	1000	160	7500	1250	1250	22,5
QPH1210HP5RR-CDB*	5 runners	reusable	✓	closed	1200	1000	160	7500	1500	2000	22,5
QPH1210HP5RR-CDG*	5 runners	reusable	✓	closed	1200	1000	160	7500	1250	2000	22,5

TRAILER LOADS

ARTICLE	STANDARD TRAILER*		COMBI*		20' HC CONTAINER*		40' HC CONTAINER*	
	STACK	TOTAL	STACK	TOTAL	STACK	TOTAL	STACK	TOTAL
Recypal1210R	23	506	23	552	17	170	17	357
Recypal1210RR	23	506	23	552	17	170	17	357
QPH1210HP3RR-CDG	15	390	17	510	16	160	16	336
QPH1210HP3RR-CDB	15	390	17	510	16	160	16	336
QPH1210HP3RR-CDG*	15	390	17	510	16	160	16	336
QPH1210HP3RR-CDB*	15	390	17	510	16	160	16	336
QPH1210HP5RR-CDB	15	390	17	510	16	160	16	336
QPH1210HP5RR-CDG	15	390	17	510	16	160	16	336
QPH1210HP5RR-CDB*	15	390	17	510	16	160	16	336
QPH1210HP5RR-CDG*	15	390	17	510	16	160	16	336



* Standard trailer: 13.60 x 2.44 - 2.48 x 2.65 m (l x w x h) / Combi: 7.60-7.60 x 2.45 x 3.00 m (l x w x h) / 20'HC (internal dimensions): 5.90 x 2.35 x 2.70 m (l x w x h) / 40' HC (internal dimensions): 12.00 x 2.35 x 2.70 m (l x w x h)



RECPAL1210RR



AVAILABLE OPTIONS

-  EDS
-  FIRE RETARDANT

-  ANTI SLIP
-  RAL COLOR

-  PRINTING WITH LOGO AND / OR TEXT

1000 x 1200 mm



QPH1210HP3RR-CDG



QPH1210HP5RR-CDB







AUTOMOTIVE INDUSTRY

Plastic pallets are becoming ever more popular in the automotive industry. Now that wooden pallets from an open pallet pool are becoming increasingly inadequate, many companies opt for purchasing their own plastic pallets. These must fit the conveyor belt systems that are characteristic of the automotive industry, complete with electronic traceability. That is the case with our pallets. They also have excellent antistatic properties, which means even the most delicate technical parts can be transported by pallet. Everything runs smoothly in the automotive industry with Q-PALL.





1020 x 1220 mm

OUR PRODUCTS

1020 X 1220 MM

1020 X 1220 MM MEDIUM

40' X 48' AMERICAN STANDARD

L	Light pallet
M	Medium pallet
H	Heavy pallet
↕	Reusable pallet
→	One-way pallet

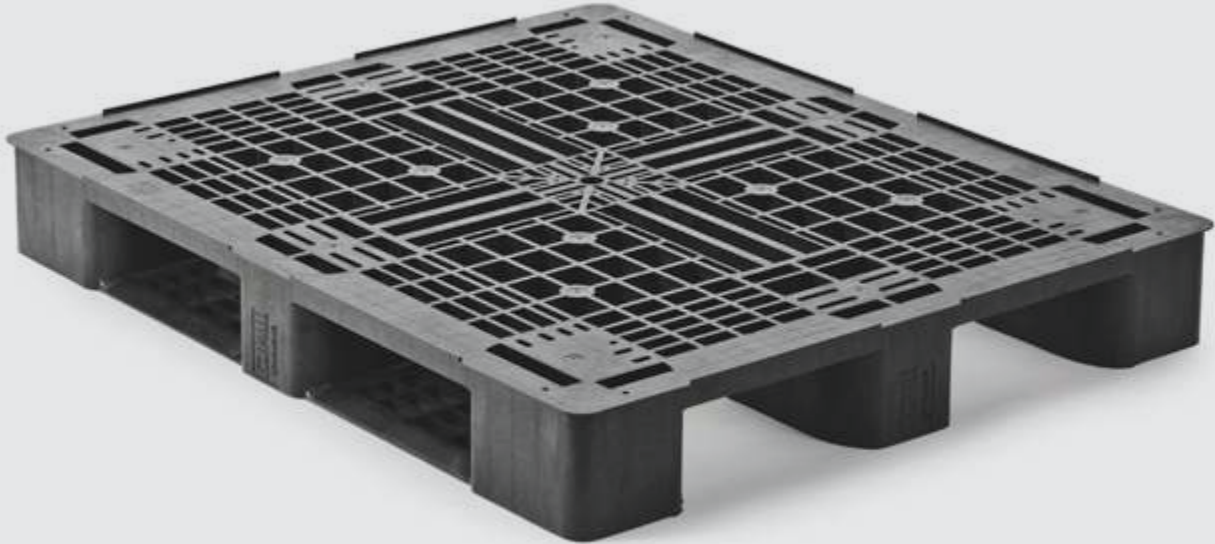

QP4048MR3RR



SPECIFICATIONS

ARTICLE	BOTTOM	USE	RIM	TOPDECK	DIMENSIONS			LOAD			
					LENGTH	WIDTH	HEIGHT	STATIC	DYNAMIC	RACKING	WEIGHT
QP4048MB3R	3 runners	one-way	-	open	1220	1020	150	6000	1250	350	15,54
QP4048MB3RR	3 runners	one-way	✓	open	1220	1020	150	6000	1250	350	15,54
QP4048MR3R	3 runners	reusable	-	open	1220	1020	150	6000	1250	350	15,09
QP4048MR3RR	3 runners	reusable	✓	open	1220	1020	150	6000	1250	350	15,09
QP4048MB3R-CD	3 runners	one-way	-	closed	1220	1020	150	6000	1250	1000	17,75
QP4048MB3RR-CD	3 runners	one-way	✓	closed	1220	1020	150	6000	1250	1000	17,75
QP4048MR3R-CD	3 runners	reusable	-	closed	1220	1020	150	6000	1250	1000	16,25
QP4048MR3RR-CD	3 runners	reusable	✓	closed	1220	1020	150	6000	1250	1000	16,25

TRAILER LOADS

ARTICLE	STANDARD TRAILER*		COMBI*		20' HC CONTAINER*		40' HC CONTAINER*	
	STACK	TOTAL	STACK	TOTAL	STACK	TOTAL	STACK	TOTAL
QP4048MB3R	17	442	19	570	17	170	17	357
QP4048MB3RR	17	442	19	570	17	170	17	357
QP4048MR3R	17	442	19	570	17	170	17	357
QP4048MR3RR	17	442	19	570	17	170	17	357
QP4048MB3R-CD	17	442	19	570	17	170	17	357
QP4048MB3RR-CD	17	442	19	570	17	170	17	357
QP4048MR3R-CD	17	442	19	570	17	170	17	357
QP4048MR3RR-CD	17	442	19	570	17	170	17	357

* Standard trailer: 13.60 x 2.44 - 2.48 x 2.65 m (l x w x h) / Combi: 7.60-7.60 x 2.45 x 3.00 m (l x w x h) / 20' HC (internal dimensions): 5.90 x 2.35 x 2.70 m (l x w x h) / 40' HC (internal dimensions): 12.00 x 2.35 x 2.70 m (l x w x h)



QP4048MR3RR

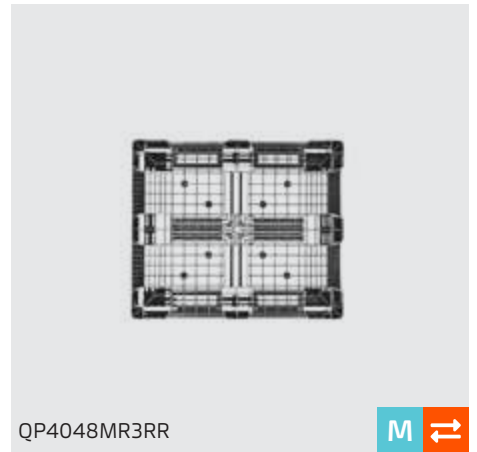

QP4048MR3RR



QP4048MR3RR



AVAILABLE OPTIONS



EDS



ANTI SLIP



PRINTING WITH LOGO AND / OR TEXT



FIRE RETARDANT



RAL COLOR



QP4048MR3RR-CD

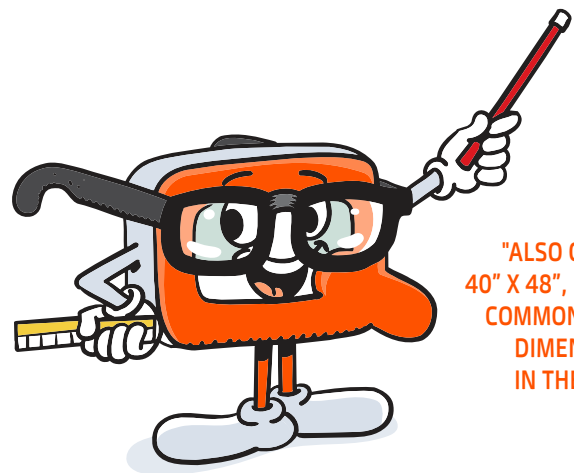

"ALSO CALLED 40" X 48", THE MOST COMMON PALLET DIMENSION IN THE U.S."



QP4048MR3RR-CD



1020 x 1220 mm

1020 X 1220 MM MEDIUM

40' X 48' AMERICAN STANDARD

L	Light pallet
M	Medium pallet
H	Heavy pallet
↕	Reusable pallet
→	One-way pallet



QP4048MB6R-CD



SPECIFICATIONS

ARTICLE	BOTTOM	USE	RIM	TOPDECK	DIMENSIONS			LOAD			
					LENGTH	WIDTH	HEIGHT	STATIC	DYNAMIC	RACKING	WEIGHT
QP4048MB6R	6 runners	one-way	-	open	1220	1020	150	6000	1250	800	16,10
QP4048MB6RR	6 runners	one-way	✓	open	1220	1020	150	6000	1250	800	16,10
QP4048MR6R	6 runners	reusable	-	open	1220	1020	150	6000	1250	800	16,05
QP4048MR6RR	6 runners	reusable	✓	open	1220	1020	150	6000	1250	800	16,05
QP4048MB6R-CD	6 runners	one-way	-	closed	1220	1020	150	6000	1250	1000	16,90
QP4048MB6RR-CD	6 runners	one-way	✓	closed	1220	1020	150	6000	1250	1000	16,90
QP4048MR6R-CD	6 runners	reusable	-	closed	1220	1020	150	6000	1250	1000	17,21
QP4048MR6RR-CD	6 runners	reusable	✓	closed	1220	1020	150	6000	1250	1000	17,21

TRAILER LOADS

ARTICLE	STANDARD TRAILER*		COMBI*		20' HC CONTAINER*		40' HC CONTAINER*	
	STACK	TOTAL	STACK	TOTAL	STACK	TOTAL	STACK	TOTAL
QP4048MB6R	17	442	19	570	17	170	17	357
QP4048MB6RR	17	442	19	570	17	170	17	357
QP4048MR6R	17	442	19	570	17	170	17	357
QP4048MR6RR	17	442	19	570	17	170	17	357
QP4048MB6R-CD	17	442	19	570	17	170	17	357
QP4048MB6RR-CD	17	442	19	570	17	170	17	357
QP4048MR6R-CD	17	442	19	570	17	170	17	357
QP4048MR6RR-CD	17	442	19	570	17	170	17	357

* Standard trailer: 13.60 x 2.44 - 2.48 x 2.65 m (l x w x h) / Combi: 7.60-7.60 x 2.45 x 3.00 m (l x w x h) / 20' HC (internal dimensions): 5.90 x 2.35 x 2.70 m (l x w x h) / 40' HC (internal dimensions): 12.00 x 2.35 x 2.70 m (l x w x h)



QP4048MB6R-CD



QP4048MB6R-CD



AVAILABLE OPTIONS



EDS



ANTI SLIP



PRINTING WITH LOGO AND / OR TEXT



FIRE RETARDANT



RAL COLOR



QP4048MB6R

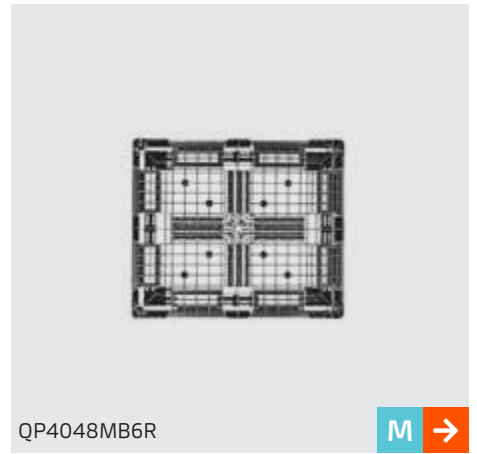

QP4048MB6R

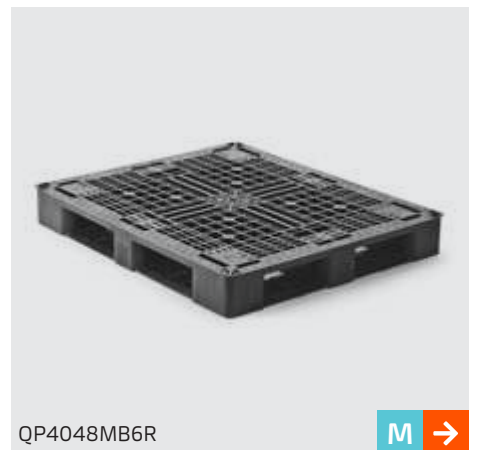

QP4048MB6R



1020 x 1220 mm



OUR PRODUCTS

1100 X 1100 MM



1100 x 1100 mm

1100 X 1100 MM LIGHT

L	Light pallet
M	Medium pallet
H	Heavy pallet
↕	Reusable pallet
→	One-way pallet



QP1111LR3RR



SPECIFICATIONS

ARTICLE	BOTTOM	USE	RIM	TOPDECK	DIMENSIONS			LOAD			WEIGHT
					LENGTH	WIDTH	HEIGHT	STATIC	DYNAMIC	RACKING	
QP1111LR9F	9 feet nestable	one-way	-	open	1100	1100	150	2500	1000	0	6,62
QP1111LR9FR	9 feet nestable	one-way	✓	open	1100	1100	150	2500	1000	0	6,62
QP1111LR3R	3 runners	one-way	-	open	1100	1100	150	2500	1000	0	8,45
QP1111LR3RR	3 runners	one-way	✓	open	1100	1100	150	2500	1000	0	8,45

TRAILER LOADS

ARTICLE	STANDARD TRAILER*		COMBI*		20' HC CONTAINER*		40' HC CONTAINER*	
	STACK	TOTAL	STACK	TOTAL	STACK	TOTAL	STACK	TOTAL
QP1111LR9F	55	1320	60	1560	55	550	55	1100
QP1111LR9FR	55	1320	60	1560	55	550	55	1100
QP1111LR3R	16	384	17	442	16	160	16	320
QP1111LR3RR	16	384	17	442	16	160	16	320

* Standard trailer: 13.60 x 2.44 - 2.48 x 2.65 m (l x w x h) / Combi: 7.60-7.60 x 2.45 x 3.00 m (l x w x h) / 20' HC (internal dimensions): 5.90 x 2.35 x 2.70 m (l x w x h) / 40' HC (internal dimensions): 12.00 x 2.35 x 2.70 m (l x w x h)



QP1111LR9FR



AVAILABLE OPTIONS



EDS



ANTI SLIP



PRINTING WITH LOGO AND / OR TEXT



FIRE RETARDANT



RAL COLOR

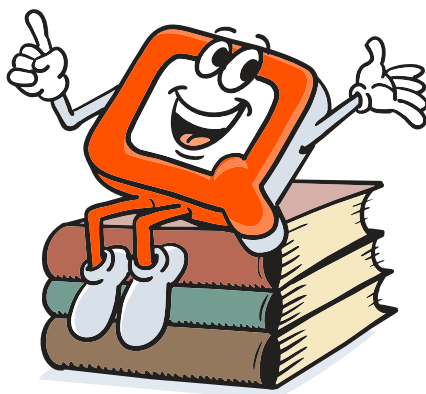

"MOST POPULAR
SIZE PALLET FOR
EXPORT TO ASIA"



1100 x 1100 mm

QP1111LR9FR



QP1111LR3RR



1100 X 1100 MM MEDIUM

L	Light pallet
M	Medium pallet
H	Heavy pallet
↕	Reusable pallet
→	One-way pallet



QP1111MR3R-AS



SPECIFICATIONS

ARTICLE	BOTTOM	USE	RIM	TOPDECK	DIMENSIONS			LOAD			WEIGHT
					LENGTH	WIDTH	HEIGHT	STATIC	DYNAMIC	RACKING	
QP1111MB3R-AS	3 runners	one-way	Anti slip stack nock	open	1100	1100	150	5000	1250	250	12,00
QP1111MR3R-AS	3 runners	reusable	Anti slip stack nock	open	1100	1100	150	5000	1250	250	11,79
QP1111MB6R-AS	6 runners	one-way	Anti slip stack nock	open	1100	1100	150	5000	1250	250	13,54
QP1111MR6R-AS	6 runners	reusable	Anti slip stack nock	open	1100	1100	150	5000	1250	250	12,94

TRAILER LOADS

ARTICLE	STANDARD TRAILER*		COMBI*		20' HC CONTAINER*		40' HC CONTAINER*	
	STACK	TOTAL	STACK	TOTAL	STACK	TOTAL	STACK	TOTAL
QP1111MB3R-AS	17	408	19	494	17	170	17	357
QP1111MR3R-AS	17	408	19	494	17	170	17	357
QP1111MB6R-AS	17	408	19	494	17	170	17	357
QP1111MR6R-AS	17	408	19	494	17	170	17	357

* Standard trailer: 13.60 x 2.44 - 2.48 x 2.65 m (l x w x h) / Combi: 7.60-7.60 x 2.45 x 3.00 m (l x w x h) / 20' HC (internal dimensions): 5.90 x 2.35 x 2.70 m (l x w x h) / 40' HC (internal dimensions): 12.00 x 2.35 x 2.70 m (l x w x h)



QP1111MR3R-AS



QP1111MR3R-AS



Anti slip|stack nock

AVAILABLE OPTIONS



EDS



ANTI SLIP



PRINTING WITH LOGO AND / OR TEXT



FIRE RETARDANT



RAL COLOR



QP1111MR6R-AS



QP1111MR6R-AS



QP1111MR6R-AS



1100 x 1100 mm



Demag



Demag



Mann



OUR PRODUCTS

1100 X 1300 MM

1100 x 1300 mm

1100 X 1300 MM MEDIUM

L	Light pallet
M	Medium pallet
H	Heavy pallet
↕	Reusable pallet
→	One-way pallet

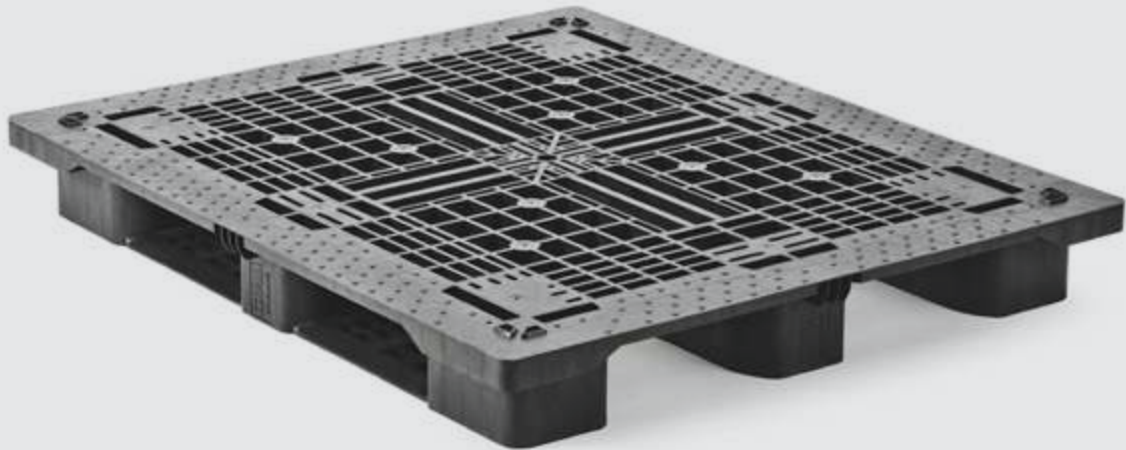

QP1311MR3R-AS



SPECIFICATIONS

ARTICLE	BOTTOM	USE	RIM	TOPDECK	DIMENSIONS			LOAD			
					LENGTH	WIDTH	HEIGHT	STATIC	DYNAMIC	RACKING	WEIGHT
QP1311MB3R-AS	3 runners	one-way	Anti slip stack nock	open	1300	1100	150	6000	1250	350	16,70
QP1311MR3R-AS	3 runners	reusable	Anti slip stack nock	open	1300	1100	150	6000	1250	350	16,70
QP1311MB6R-AS	6 runners	one-way	Anti slip stack nock	open	1300	1100	150	6000	1250	800	17,51
QP1311MR6R-AS	6 runners	reusable	Anti slip stack nock	open	1300	1100	150	6000	1250	800	17,51
QP1311MB3R-ASCD	3 runners	one-way	Anti slip stack nock	closed	1300	1100	150	6000	1250	350	18,71
QP1311MR3R-ASCD	3 runners	reusable	Anti slip stack nock	closed	1300	1100	150	6000	1250	350	18,71
QP1311MB6R-ASCD	6 runners	one-way	Anti slip stack nock	closed	1300	1100	150	6000	1250	800	19,52
QP1311MR6R-ASCD	6 runners	reusable	Anti slip stack nock	closed	1300	1100	150	6000	1250	800	19,52

TRAILER LOADS

ARTICLE	STANDARD TRAILER*		COMBI*		20' HC CONTAINER*		40' HC CONTAINER*	
	STACK	TOTAL	STACK	TOTAL	STACK	TOTAL	STACK	TOTAL
QP1311MB3R-AS	15	330	17	408	16	160	16	336
QP1311MR3R-AS	15	330	17	408	16	160	16	336
QP1311MB6R-AS	15	330	17	408	16	160	16	336
QP1311MR6R-AS	15	330	17	408	16	160	16	336
QP1311MB3R-ASCD	15	330	17	408	16	160	16	336
QP1311MR3R-ASCD	15	330	17	408	16	160	16	336
QP1311MB6R-ASCD	15	330	17	408	16	160	16	336
QP1311MR6R-ASCD	15	330	17	408	16	160	16	336

* Standard trailer: 13.60 x 2.44 - 2.48 x 2.65 m (l x w x h) / Combi: 7.60-7.60 x 2.45 x 3.00 m (l x w x h) / 20' HC (internal dimensions): 5.90 x 2.35 x 2.70 m (l x w x h) / 40' HC (internal dimensions): 12.00 x 2.35 x 2.70 m (l x w x h)



QP1311MR3R-ASCD



QP1311MR3R-ASCD



QP1311MR6R-AS



AVAILABLE OPTIONS

- EDS
- FIRE RETARDANT

- ANTI SLIP
- RAL COLOR

- PRINTING WITH LOGO AND / OR TEXT

"SUITABLE FOR USE IN THE
FOOD AND PHARMACEUTICAL
INDUSTRIES"



QP1311MR3R-AS



1100 x 1300 mm



QP1311MR6R-ASCD



QP1311MR6R-AS



1100 X 1300 MM HEAVY

L	Light pallet
M	Medium pallet
H	Heavy pallet
↕	Reusable pallet
→	One-way pallet



QP1311HR3RL



SPECIFICATIONS

ARTICLE	BOTTOM	USE	RIM	TOPDECK	DIMENSIONS			LOAD			
					LENGTH	WIDTH	HEIGHT	STATIC	DYNAMIC	RACKING	WEIGHT
QP1311HB3RL	3 runners	one-way	L-rib	open	1300	1100	160	7500	1500	1250	21,99
QP1311HR3RL	3 runners	reusable	L-rib	open	1300	1100	160	7500	1500	1250	21,99
QP1311HB5RL	5 runners	one-way	L-rib	open	1300	1100	160	7500	1500	1250	23,66
QP1311HR5RL	5 runners	reusable	L-rib	open	1300	1100	160	7500	1500	1250	23,66
QP1311HB3R-AS	3 runners	one-way	Anti slip stack nock	open	1300	1100	158	7500	1500	1250	23,06
QP1311HR3R-AS	3 runners	reusable	Anti slip stack nock	open	1300	1100	158	7500	1500	1250	23,06
QP1311HB6R-AS	6 runners	one-way	Anti slip stack nock	open	1300	1100	158	7500	1500	1250	23,55
QP1311HR6R-AS	6 runners	reusable	Anti slip stack nock	open	1300	1100	158	7500	1500	1250	23,55
QP1311HB3R-ASCD	3 runners	one-way	Anti slip stack nock	closed	1300	1100	158	7500	1500	1250	24,55
QP1311HR3R-ASCD	3 runners	reusable	Anti slip stack nock	closed	1300	1100	158	7500	1500	1250	24,55
QP1311HB6R-ASCD	6 runners	one-way	Anti slip stack nock	closed	1300	1100	158	7500	1500	1250	26,50
QP1311HR6R-ASCD	6 runners	reusable	Anti slip stack nock	closed	1300	1100	158	7500	1500	1250	26,50

TRAILER LOADS

ARTICLE	STANDARD TRAILER*		COMBI*		20' HC CONTAINER*		40' HC CONTAINER*	
	STACK	TOTAL	STACK	TOTAL	STACK	TOTAL	STACK	TOTAL
QP1311HB3RL	15	330	17	408	16	160	16	336
QP1311HR3RL	15	330	17	408	16	160	16	336
QP1311HB5RL	15	330	17	408	16	160	16	336
QP1311HR5RL	15	330	17	408	16	160	16	336
QP1311HB3R-AS	15	330	17	408	16	160	16	336
QP1311HR3R-AS	15	330	17	408	16	160	16	336
QP1311HB6R-AS	15	330	17	408	16	160	16	336
QP1311HR6R-AS	15	330	17	408	16	160	16	336
QP1311HB3R-ASCD	15	330	17	408	16	160	16	336
QP1311HR3R-ASCD	15	330	17	408	16	160	16	336
QP1311HB6R-ASCD	15	330	17	408	16	160	16	336
QP1311HR6R-ASCD	15	330	17	408	16	160	16	336

* Standard trailer: 13.60 x 2.44 - 2.48 x 2.65 m (l x w x h) / Combi: 7.60-7.60 x 2.45 x 3.00 m (l x w x h) / 20'HC (internal dimensions): 5.90 x 2.35 x 2.70 m (l x w x h) / 40' HC (internal dimensions): 12.00 x 2.35 x 2.70 m (l x w x h)



QP1311HR5RL



QP1311HR3RL



QP1311HR5RL



AVAILABLE OPTIONS



EDS



ANTI SLIP



PRINTING WITH LOGO AND / OR TEXT



FIRE RETARDANT



RAL COLOR



QP1311HR3R-AS

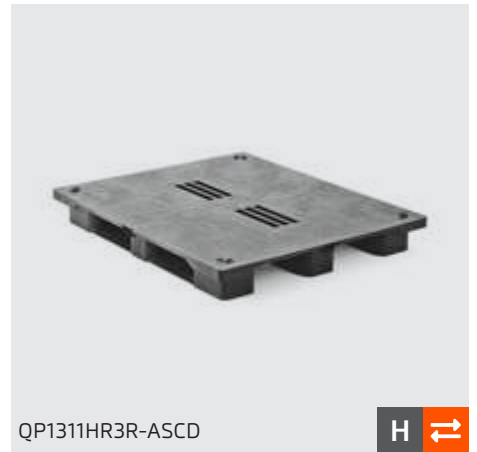

QP1311HR3R-ASCD

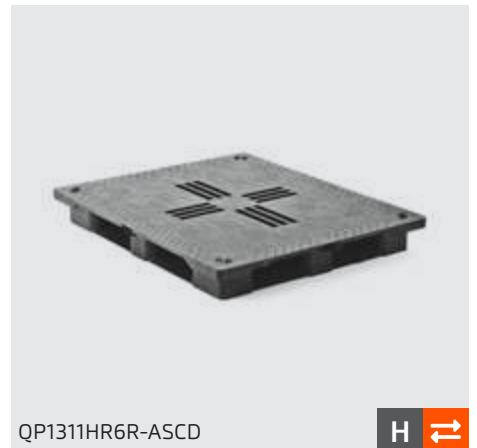

QP1311HR6R-ASCD



1100 x 1300 mm





CHEMICAL INDUSTRY

Every market sets its own requirements to the pallets they use and that certainly applies to the chemical industry. There is a good reason this industry has its own CP pallet. There is a large diversity of complex, automated warehouses and distribution centres. Pallets are an indispensable part of these modern systems. You want a pallet that connects seamlessly to your handling solution for a reliable, uninterrupted process. That is exactly what Q-PALL can offer you. Q-PALL has a broad range: from CP1 though CP9. All designed with a focus on efficiency and cost savings.





OUR PRODUCTS

1140 X 1140 MM

1140 x 1140 mm

1140 X 1140 MM LIGHT

L	Light pallet
M	Medium pallet
H	Heavy pallet
↕	Reusable pallet
→	One-way pallet



SPECIFICATIONS

ARTICLE	BOTTOM	USE	RIM	TOPDECK	DIMENSIONS			LOAD			WEIGHT
					LENGTH	WIDTH	HEIGHT	STATIC	DYNAMIC	RACKING	
QP1140LR9F	9 feet nestable	one-way	-	open	1140	1140	150	2500	1000	0	7,53
QP1140LR9FR	9 feet nestable	one-way	✓	open	1140	1140	150	2500	1000	0	7,53
QP1140LR3R	3 runners	one-way	-	open	1140	1140	150	2500	1000	0	9,36
QP1140LR3RR	3 runners	one-way	✓	open	1140	1140	150	2500	1000	0	9,36

TRAILER LOADS

ARTICLE	STANDARD TRAILER*		COMBI*		20' HC CONTAINER*		40' HC CONTAINER*	
	STACK	TOTAL	STACK	TOTAL	STACK	TOTAL	STACK	TOTAL
QP1140LR9F	55	1210	60	1560	55	550	55	1100
QP1140LR9FR	55	1210	60	1560	55	550	55	1100
QP1140LR3R	16	352	17	442	16	160	16	320
QP1140LR3RR	16	352	17	442	16	160	16	320

* Standard trailer: 13.60 x 2.44 - 2.48 x 2.65 m (L x w x h) / Combi: 7.60-7.60 x 2.45 x 3.00 m (L x w x h) / 20' HC (internal dimensions): 5.90 x 2.35 x 2.70 m (L x w x h) / 40' HC (internal dimensions): 12.00 x 2.35 x 2.70 m (L x w x h)



QP1140LR9FR



AVAILABLE OPTIONS



EDS



ANTI SLIP



PRINTING WITH LOGO AND / OR TEXT



FIRE RETARDANT



RAL COLOR



QP1140LR9FR



"MAKE OPTIMUM
USE OF THE CARGO
COMPARTMENT IN THE
OVERSEA CONTAINER"

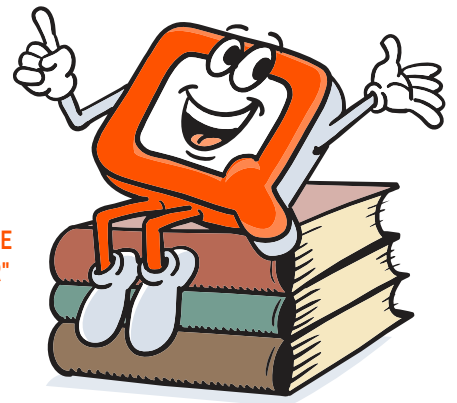

QP1140LR3RR



1140 x 1140 mm

1140 X 1140 MM MEDIUM

L	Light pallet
M	Medium pallet
H	Heavy pallet
↕	Reusable pallet
→	One-way pallet



QP1140MR3R-PAS

SPECIFICATIONS

ARTICLE	BOTTOM	USE	RIM	TOPDECK	DIMENSIONS			LOAD			WEIGHT
					LENGTH	WIDTH	HEIGHTS	STATIC	DYNAMIC	RACKING	
QP1140MB3R	3 runners	one-way	-	open	1140	1140	156	7500	1375	250	15,31
QP1140MB3RR	3 runners	one-way	✓	open	1140	1140	156	7500	1375	250	15,31
QP1140MR3R	3 runners	reusable	-	open	1140	1140	156	7500	1375	250	15,12
QP1140MR3RR	3 runners	reusable	✓	open	1140	1140	156	7500	1375	250	15,12
QP1140MR6R	6 runners	reusable	-	open	1140	1140	156	7500	1375	250	16,95
QP1140MR6RR	6 runners	reusable	✓	open	1140	1140	156	7500	1375	250	16,95
QP1140MB6R	6 runners	one-way	-	open	1140	1140	156	7500	1375	250	16,99
QP1140MB6RR	6 runners	one-way	✓	open	1140	1140	156	7500	1375	250	16,99
QP1140MB3R-PAS	3 runners	one-way	Anti slip stack nock	open	1140	1140	150	7500	1375	250	13,51
QP1140MR3R-PAS	3 runners	reusable	Anti slip stack nock	open	1140	1140	150	7500	1375	250	13,36
QP1140MB6R-PAS	6 runners	one-way	Anti slip stack nock	open	1140	1140	150	7500	1375	250	14,25
QP1140MR6R-PAS	6 runners	reusable	Anti slip stack nock	open	1140	1140	150	7500	1375	250	14,27

TRAILER LOADS

ARTICLE	STANDARD TRAILER*		COMBI*		20' HC CONTAINER*		40' HC CONTAINER*	
	STACK	TOTAL	STACK	TOTAL	STACK	TOTAL	STACK	TOTAL
QP1140MB3R	17	374	19	494	17	170	17	357
QP1140MB3RR	17	374	19	494	17	170	17	357
QP1140MR3R	17	374	19	494	17	170	17	357
QP1140MR3RR	17	374	19	494	17	170	17	357
QP1140MR6R	17	374	19	494	17	170	17	357
QP1140MR6RR	17	374	19	494	17	170	17	357
QP1140MB6R	17	374	19	494	17	170	17	357
QP1140MB6RR	17	374	19	494	17	170	17	357
QP1140MB3R-PAS	17	374	19	494	17	170	17	357
QP1140MR3R-PAS	17	374	19	494	17	170	17	357
QP1140MB6R-PAS	17	374	19	494	17	170	17	357
QP1140MR6R-PAS	17	374	19	494	17	170	17	357

* Standard trailer: 13.60 x 2.44 - 2.48 x 2.65 m (L x w x h) / Combi: 7.60-7.60 x 2.45 x 3.00 m (L x w x h) / 20' HC (internal dimensions): 5.90 x 2.35 x 2.70 m (L x w x h) / 40' HC (internal dimensions): 12.00 x 2.35 x 2.70 m (L x w x h)



QP1140MR6R-PAS



QP1140MR3R-PAS

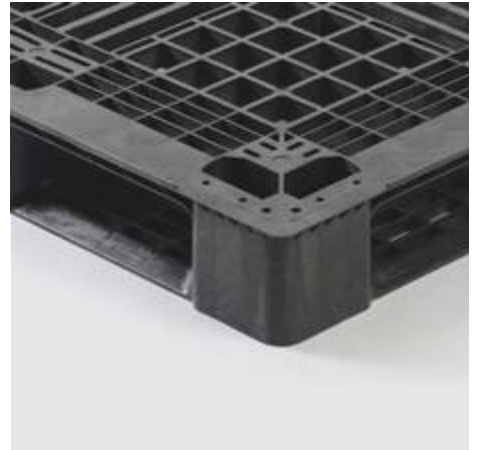

AVAILABLE OPTIONS



EDS



ANTI SLIP



PRINTING WITH LOGO AND / OR TEXT



FIRE RETARDANT



RAL COLOR



QP1140MR6RR

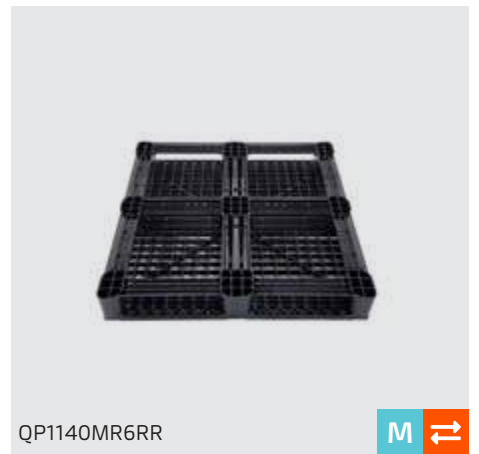

QP1140MR6RR

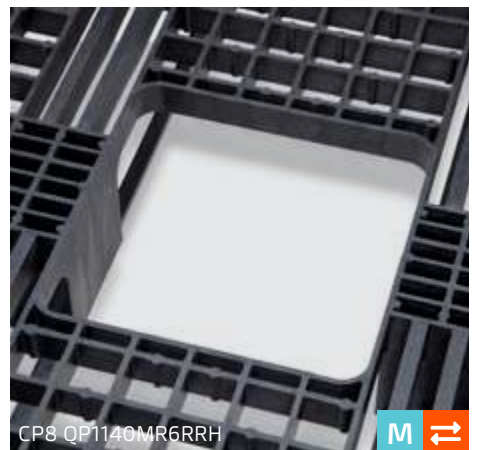

CP8 QP1140MR6RRH



1140 x 1140 mm

1140 X 1140 MM HEAVY

L	Light pallet
M	Medium pallet
H	Heavy pallet
↕	Reusable pallet
→	One-way pallet



QP1140HR6RR



SPECIFICATIONS

ARTICLE	BOTTOM	USE	RIM	TOPDECK	DIMENSIONS			LOAD			
					LENGTH	WIDTH	HEIGHT	STATIC	DYNAMIC	RACKING	WEIGHT
QP1140HR3R	3 runners	one-way	-	open	1140	1140	170	7500	1500	1000	24,50
QP1140HR3RR	3 runners	one-way	✓	open	1140	1140	170	7500	1500	1000	24,50
QP1140HP3R	3 runners	reusable	-	open	1140	1140	170	7500	1500	1000	24,50
QP1140HP3RR	3 runners	reusable	✓	open	1140	1140	170	7500	1500	1000	24,50
QP1140HR6R	6 runners	one-way	-	open	1140	1140	170	7500	1500	1250	26,00
QP1140HR6RR	6 runners	one-way	✓	open	1140	1140	170	7500	1500	1250	26,00
QP1140HP6R	6 runners	reusable	-	open	1140	1140	170	7500	1500	1250	25,50
QP1140HP6RR	6 runners	reusable	✓	open	1140	1140	170	7500	1500	1250	25,50
QP1140HB3R-ASCD	3 runners	one-way	Anti slip stack nock	closed	1140	1140	160	7500	1750	1000	23,76
QP1140HR3R-ASCD	3 runners	reusable	Anti slip stack nock	closed	1140	1140	160	7500	1750	1000	23,52
QP1140HB6R-ASCD	6 runners	one-way	Anti slip stack nock	closed	1140	1140	160	7500	1750	1250	26,01
QP1140HR6R-ASCD	6 runners	reusable	Anti slip stack nock	closed	1140	1140	160	7500	1750	1250	25,70

TRAILER LOADS

ARTICLE	STANDARD TRAILER*		COMBI*		20' HC CONTAINER*		40' HC CONTAINER*	
	STACK	TOTAL	STACK	TOTAL	STACK	TOTAL	STACK	TOTAL
QP1140HR3R	15	330	17	442	15	150	15	300
QP1140HR3RR	15	330	17	442	15	150	15	300
QP1140HP3R	15	330	17	442	15	150	15	300
QP1140HP3RR	15	330	17	442	15	150	15	300
QP1140HR6R	15	330	17	442	15	150	15	300
QP1140HR6RR	15	330	17	442	15	150	15	300
QP1140HP6R	15	330	17	442	15	150	15	300
QP1140HP6RR	15	330	17	442	15	150	15	300
QP1140HB3R-ASCD	16	352	18	468	16	160	16	320
QP1140HR3R-ASCD	16	352	18	468	16	160	16	320
QP1140HB6R-ASCD	16	352	18	468	16	160	16	320
QP1140HR6R-ASCD	16	352	18	468	16	160	16	320

* Standard trailer: 13.60 x 2.44 - 2.48 x 2.65 m (l x w x h) / Combi: 7.60-7.60 x 2.45 x 3.00 m (l x w x h) / 20'HC (internal dimensions): 5.90 x 2.35 x 2.70 m (l x w x h) / 40' HC (internal dimensions): 12.00 x 2.35 x 2.70 m (l x w x h)



QP1140HR3RR



QP1140HR3RR



QP1140HR6RR



AVAILABLE OPTIONS



EDS



ANTI SLIP



PRINTING WITH LOGO AND / OR TEXT



FIRE RETARDANT



RAL COLOR



QP1140HR6R-ASCD



QP1140HR3R-ASCD

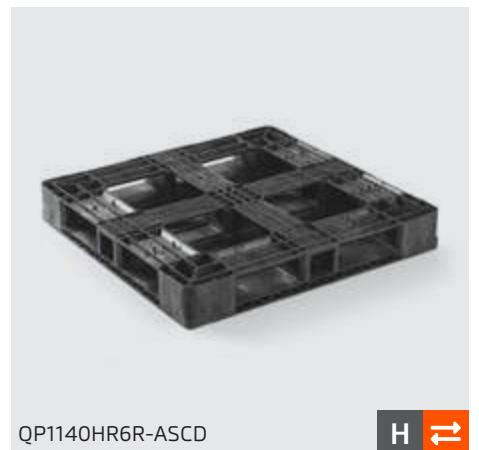

QP1140HR6R-ASCD



1140 x 1140 mm





OUR PRODUCTS

1200 X 1200 MM

1200 x 1200 mm

1200 X 1200 MM LIGHT

L	Light pallet
M	Medium pallet
H	Heavy pallet
↕	Reusable pallet
→	One-way pallet



QP1212LR3RR



SPECIFICATIONS

ARTICLE	BOTTOM	USE	RIM	TOPDECK	DIMENSIONS			LOAD			
					LENGTH	WIDTH	HEIGHT	STATIC	DYNAMIC	RACKING	WEIGHT
QP1212LR9F	9 feet nestable	one-way	-	open	1200	1200	150	2500	1000	0	8,34
QP1212LR9FR	9 feet nestable	one-way	✓	open	1200	1200	150	2500	1000	0	8,34
QP1212LR3R	3 runners	one-way	-	open	1200	1200	150	2500	1000	0	10,29
QP1212LR3RR	3 runners	one-way	✓	open	1200	1200	150	2500	1000	0	10,29

TRAILER LOADS

ARTICLE	STANDARD TRAILER*		COMBI*		20' HC CONTAINER*		40' HC CONTAINER*	
	STACK	TOTAL	STACK	TOTAL	STACK	TOTAL	STACK	TOTAL
QP1212LR9F	55	1210	60	1440	55	320	55	760
QP1212LR9FR	55	1210	60	1440	55	320	55	760
QP1212LR3R	16	352	17	408	16	276	16	230
QP1212LR3RR	16	352	17	408	16	276	16	230

* Standard trailer: 13.60 x 2.44 - 2.48 x 2.65 m (l x w x h) / Combi: 7.60-7.60 x 2.45 x 3.00 m (l x w x h) / 20' HC (internal dimensions): 5.90 x 2.35 x 2.70 m (l x w x h) / 40' HC (internal dimensions): 12.00 x 2.35 x 2.70 m (l x w x h)



QP1212LR9FR



AVAILABLE OPTIONS



EDS



ANTI SLIP



PRINTING WITH LOGO AND / OR TEXT



FIRE RETARDANT



RAL COLOR



QP1212LR9FR



1200 x 1200 mm

1200 X 1200 MM MEDIUM

L	Light pallet
M	Medium pallet
H	Heavy pallet
↕	Reusable pallet
→	One-way pallet



QP1212MR3RR



SPECIFICATIONS

ARTICLE	BOTTOM	USE	RIM	TOPDECK	DIMENSIONS			LOAD			
					LENGTH	WIDTH	HEIGHT	STATIC	DYNAMIC	RACKING	WEIGHT
QP1212MB3R	3 runners	one-way	-	open	1200	1200	156	7500	1375	250	15,90
QP1212MB3RR	3 runners	one-way	✓	open	1200	1200	156	7500	1375	250	15,90
QP1212MR3R	3 runners	reusable	-	open	1200	1200	156	7500	1375	250	15,90
QP1212MR3RR	3 runners	reusable	✓	open	1200	1200	156	7500	1375	250	15,90
QP1212MB6R	6 runners	one-way	-	open	1200	1200	156	7500	1375	250	17,66
QP1212MB6RR	6 runners	one-way	✓	open	1200	1200	156	7500	1375	250	17,66
QP1212MR6R	6 runners	reusable	-	open	1200	1200	156	7500	1375	250	17,66
QP1212MR6RR	6 runners	reusable	✓	open	1200	1200	156	7500	1375	250	17,66

TRAILER LOADS

ARTICLE	STANDARD TRAILER*		COMBI*		20' HC CONTAINER*		40' HC CONTAINER*	
	STACK	TOTAL	STACK	TOTAL	STACK	TOTAL	STACK	TOTAL
QP1212MB3R	16	352	19	456	17	180	17	290
QP1212MB3RR	16	352	19	456	17	180	17	290
QP1212MR3R	16	352	19	456	17	180	17	290
QP1212MR3RR	16	352	19	456	17	180	17	290
QP1212MB6R	16	352	19	456	17	180	17	290
QP1212MB6RR	16	352	19	456	17	180	17	290
QP1212MR6R	16	352	19	456	17	180	17	290
QP1212MR6RR	16	352	19	456	17	180	17	290

* Standard trailer: 13.60 x 2.44 - 2.48 x 2.65 m (l x w x h) / Combi: 7.60-7.60 x 2.45 x 3.00 m (l x w x h) / 20'HC (internal dimensions): 5.90 x 2.35 x 2.70 m (l x w x h) / 40' HC (internal dimensions): 12.00 x 2.35 x 2.70 m (l x w x h)



QP1212MR6RR



AVAILABLE OPTIONS

- EDS
- FIRE RETARDANT

- ANTI SLIP
- RAL COLOR

- PRINTING WITH LOGO AND / OR TEXT



QP1212MR3RR



"THE 1200 X 1200 MEDIUM OR HEAVY PALLETS ARE MOSTLY USED FOR STORAGE OF BARRELS"



QP1212MR6RR



1200 x 1200 mm

1200 X 1200 MM HEAVY

L	Light pallet
M	Medium pallet
H	Heavy pallet
↕	Reusable pallet
→	One-way pallet



QP1212HP6RR



SPECIFICATIONS

ARTICLE	BOTTOM	USE	RIM	TOPDECK	DIMENSIONS			LOAD			
					LENGTH	WIDTH	HEIGHT	STATIC	DYNAMIC	RACKING	WEIGHT
QP1212HR3R	3 runners	one-way	-	open	1200	1200	170	7500	1500	1000	26,0
QP1212HR3RR	3 runners	one-way	✓	open	1200	1200	170	7500	1500	1000	26,0
QP1212HP3R	3 runners	reusable	-	open	1200	1200	170	7500	1500	1250	26,0
QP1212HP3RR	3 runners	reusable	✓	open	1200	1200	170	7500	1500	1250	26,0
QP1212HR6R	6 runners	one-way	-	open	1200	1200	170	7500	1500	1250	27,0
QP1212HR6RR	6 runners	one-way	✓	open	1200	1200	170	7500	1500	1250	27,0
QP1212HP6R	6 runners	reusable	-	open	1200	1200	170	7500	1500	1375	26,5
QP1212HP6RR	6 runners	reusable	✓	open	1200	1200	170	7500	1500	1375	26,5

TRAILER LOADS

ARTICLE	STANDARD TRAILER*		COMBI*		20' HC CONTAINER*		40' HC CONTAINER*	
	STACK	TOTAL	STACK	TOTAL	STACK	TOTAL	STACK	TOTAL
QP1212HR3R	15	330	17	408	15	108	15	270
QP1212HR3RR	15	330	17	408	15	108	15	270
QP1212HP3R	15	330	17	408	15	108	15	270
QP1212HP3RR	15	330	17	408	15	108	15	270
QP1212HR6R	15	330	17	408	15	108	15	270
QP1212HR6RR	15	330	17	408	15	108	15	270
QP1212HP6R	15	330	17	408	15	108	15	270
QP1212HP6RR	15	330	17	408	15	108	15	270

* Standard trailer: 13.60 x 2.44 - 2.48 x 2.65 m (L x w x h) / Combi: 7.60-7.60 x 2.45 x 3.00 m (L x w x h) / 20' HC (internal dimensions): 5.90 x 2.35 x 2.70 m (L x w x h) / 40' HC (internal dimensions): 12.00 x 2.35 x 2.70 m (L x w x h)



QP1212HR6RR barrel version

H →

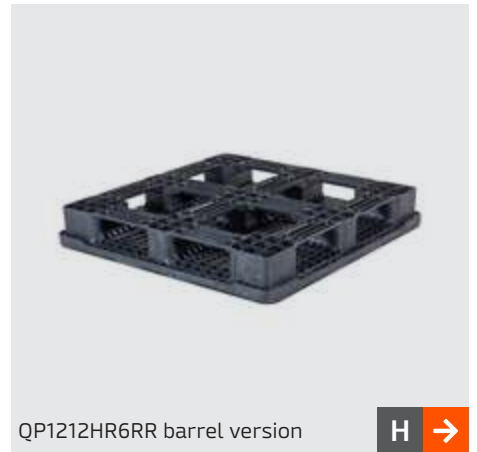

QP1212HR6RR barrel version

H →



QP1212HR6RR barrel version

H →

AVAILABLE OPTIONS



EDS



ANTI SLIP



PRINTING WITH LOGO AND / OR TEXT



FIRE RETARDANT



RAL COLOR



QP1212HR3RR

H →



QP1212HR3RR

H →

1200 x 1200 mm



wecon

64-WR-JF

wecon

wecon

wecon



OUR PRODUCTS

SPECIALS

SPECIALS

PLASTIC COLLARS AND COVERS



PLASTIC COLLARS

SPECIFICATIONS

ARTICLE	HINGE AMOUNT	HINGE THICKNESS	WALL THICKNESS	DIMENSIONS		
				LENGTH	WIDTH	HEIGHT
QPKVOUWR6080-4	4	1,25	29	800	600	200
QPKVOUWR1208-4	4	1,25	29	1200	800	200
QPKVOUWR1208-6	6	1,25	29	1200	800	200
QPKVOUWR1210-4	4	1,25	29	1200	1000	200
QPKVOUWR1210-6	6	1,25	29	1200	1000	200
QPKVOUWR1212-4	4	1,25	29	1200	1200	200

PLASTIC COVERS

SPECIFICATIONS

ARTICLE	DIMENSIONS (OUTSIDE)		
	LENGTH	WIDTH	HEIGHT
QPRDECK6080	800	600	50
QPRDECK1208	1200	800	50
QPRDECK1210	1200	1000	50



BOTTLEGUARD



BOTTLEGUARD8H

SPECIFICATIONS

ARTICLE	DIMENSIONS			LOAD		WEIGHT
	LENGTH	WIDTH	HEIGHT	STATIC	DYNAMIC	
Bottleguard8L	1200	1000	380	4500	1750	17
Bottleguard8H	1200	1000	423	4500	1750	18



BOTTLEGUARD8L

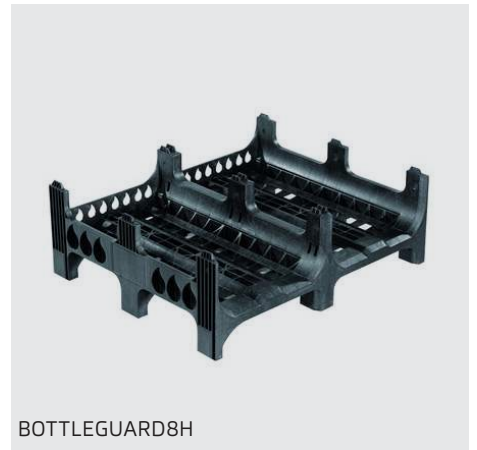

BOTTLEGUARD8H



BOTTLEGUARD8L



BOTTLEGUARD8L



BOTTLEGUARD8H

FREEZER SPACERS



TYPE1 QPFSI1210-BLACK

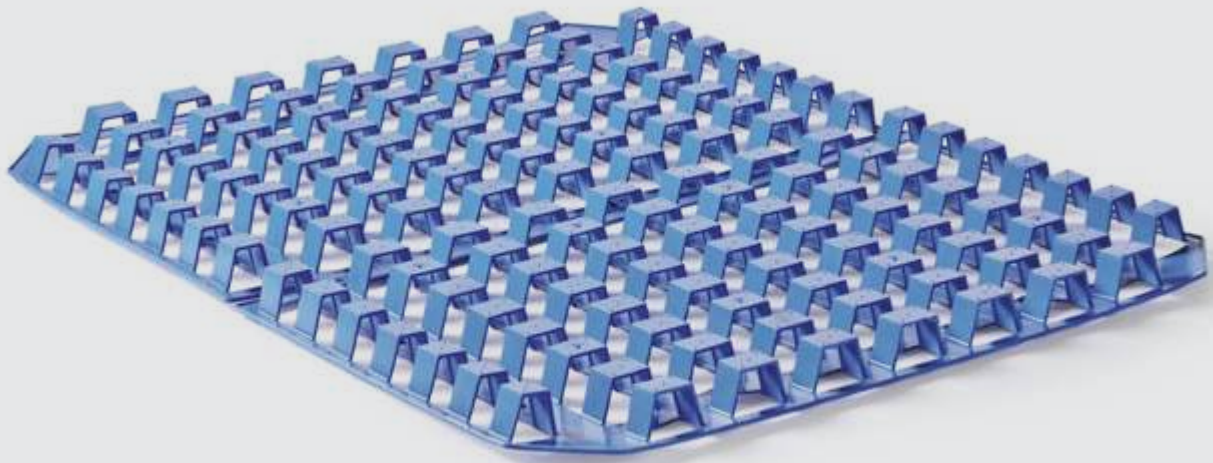

TYPE1 QPFSI1210-BLUE

SPECIFICATIONS

ARTICLE	DIMENSIONS			LOAD		WEIGHT	COULEUR
	LENGTH	WIDTH	HEIGHT	STATIC	DYNAMIC		
QPFSI1208-Black	1200	800	50	3000	1500	2,96	Black
QPFSI1208-Blue	1200	800	50	3000	1500	2,96	Blue
QPFSI1210-Black	1200	1000	50	3000	1500	3,68	Black
QPFSI1210-Blue	1200	1000	50	3000	1500	3,68	Blue
QPFSI1208-Black	1200	800	50	2000	1000	2,72	Black
QPFSI1210-Black	1200	1000	50	2000	1000	3,36	Black



QPFSII1208-BLACK



QPFSII1208-BLACK



QPFSII1210-BLACK



QPFSII1210-BLACK

ENVIRONMENTAL

The spacers are manufactured from 100% recyclable materials and can be genuinely recycled at the end of their usable life. Combined with the reduced energy consumption during freezing this benefits the environment.

PRACTICAL

The low weight and open design makes it easy to handle and to clean the Neptun freezer spacer. The spacers nest easily into each other when not in use, thereby taking up a minimum amount of space.

COST EFFECTIVE

Due to the robust structure of High-Density Polyethylene, our freezer spacer withstands temperatures between -50°C and $+90^{\circ}\text{C}$ and is resistant to acids and chemicals, ensuring a long lifespan, even in the toughest working environments.

EFFICIENT

The open profiles result in maximum air contact with the stacked layers of products, ensuring faster and more efficient freezing of the whole pallet load.

RETENTION BASIN



RETENTION BASIN

SPECIFICATIONS

ARTICLE	DIMENSIONS			LOAD		WEIGHT	CAPACITÉ (L)
	LENGTH	WIDTH	HEIGHT	STATIC	DYNAMIC		
QPBIN120L	1200	800	312	5000	1500	28	120

RETENTION BASIN + GRID

SPECIFICATIONS

ARTICLE	MATERIAL	DIMENSIONS			LOAD		WEIGHT	CAPACITÉ (L)
		LENGTH	WIDTH	HEIGHT	STATIC	DYNAMIC		
QPBIN120L-GridG	Galvanised	1200	800	-	-	-	27	-
QPBIN120L-GridK	100% recycle PE	1200	800	-	-	-	12	-

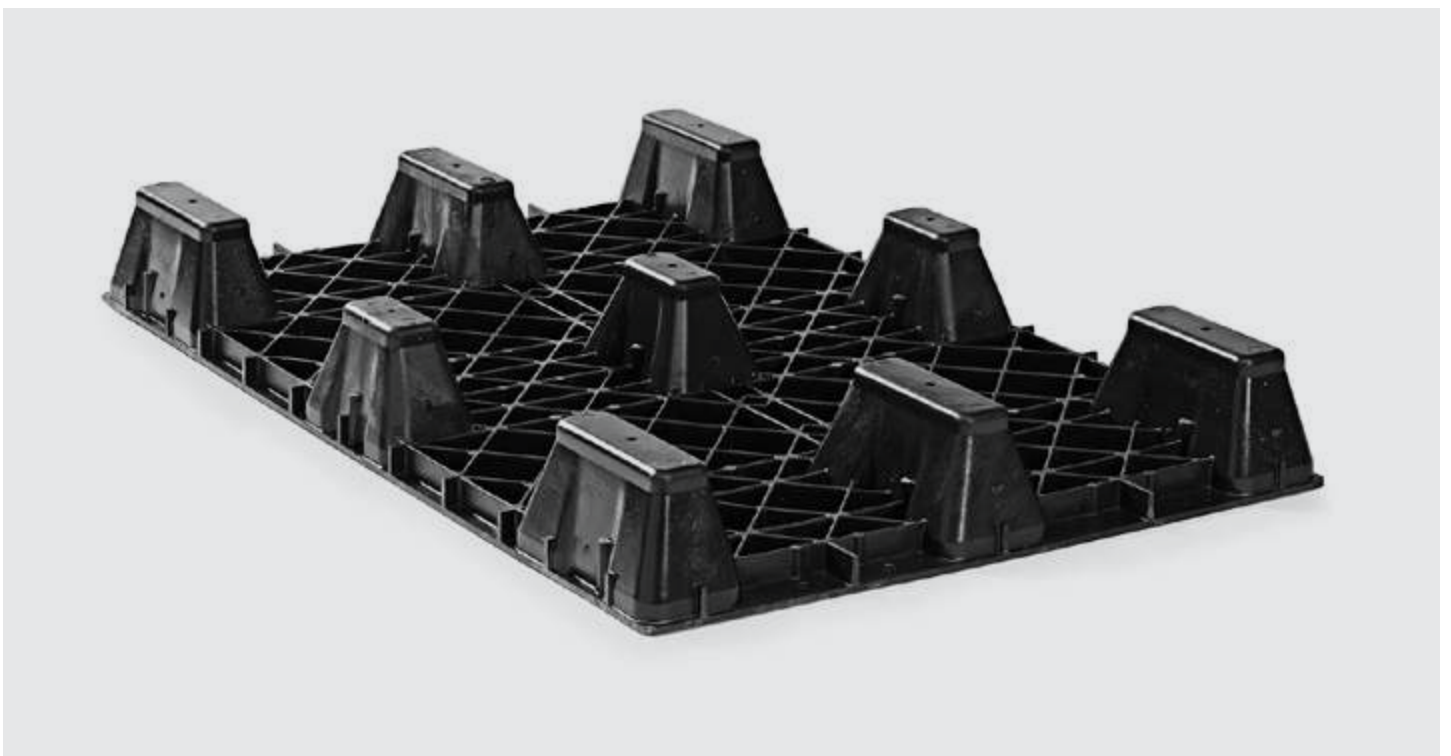





PHARMACEUTICAL INDUSTRY

Hygiene is an absolute must in the pharmaceutical industry. Without hygiene, the production process is jeopardised and medicine becomes contaminated. Unwanted guests such as fungi, insects, and bacteria are absolutely unthinkable. It is precisely in this environment that our pallets thrive. Plastic is naturally more hygienic than wood. The hygienic pallets from Q-PALL also feature an extra careful finish and a fully smooth design. No spaces or seams where dirt can accumulate. This means you can focus on what is important.

Q-PALL BV
Taylorweg 2
NL-5466 AE Veghel
The Netherlands
Phone: +31 413 353 111
E-mail: info@qpall.com

www.qpall.com

The logo consists of a white square containing a stylized 'Q' with a white arrow pointing from the bottom right towards the center. To the right of this square, the word 'PALL' is written in a bold, black, sans-serif font. A registered trademark symbol (®) is located at the top right of the 'PALL' text.
QPALL®
PLASTIC PALLETS