

PRODUCTCATALOGUS

**PALLETS WITH**

**A PURPOSE**



PLASTIC PALLETS

# DEALERS EN PRODUCTIELOCATIES

## ACTING GLOBAL SERVING LOCAL

- BELGIË**  
① **INDUPACK BVBA**  
Simon Stevinstraat 11  
BE 3920 Lommel  
België  
Telefoon: +32 11 40 35 65  
E-mail: belgium@qpall.com
- DENEMARKEN**  
② **DANSK TRANSPORT EMBALLAGE A/S**  
Postbox 127  
Industriparken 6  
DK-6500 Vojens  
Denemarken  
Telefoon: +45 74 59 16 80  
E-mail: denmark@qpall.com
- DUITSLAND**  
③ **ALPHA PALETTE & BOXEN**  
Dorfstr. 77  
49849 Wilsum  
Duitsland  
Telefoon: +49 5945 99579 0  
E-mail: germany@qpall.com
- ④ **EDMUND G. FRIEDRICH & CO. GMBH**  
Elbchaussee 60 A  
22765 Hamburg  
Duitsland  
Telefoon: +49 40 31 29 39  
E-mail: germany@qpall.com
- ⑤ **GFH KUNSTSTOFFTECHNIK**  
Am Peterfeld 4  
83024 Rosenheim  
Duitsland  
Telefoon: +49 80312068498  
E-mail: germany@qpall.com
- ⑥ **ZÖLLNER KUNSTSTOFFPRODUKTE GMBH**  
Zur Eisenkaute 12  
57299 Burbach  
Duitsland  
Telefoon: +49 2736509700  
E-mail: germany@qpall.com
- FINLAND**  
⑦ **ZYMOTEC OY**  
Kinturinkuja 4  
11120 Riihimäki  
Finland  
Telefoon: +358 19 419 428  
E-mail: finland@qpall.com
- FRANKRIJK**  
⑧ **BAC-LAND PACK**  
12 avenue Charles de Gaulle  
Batiment K  
31130 Balma  
Frankrijk  
Telefoon: +33 562 57 88 38  
E-mail: france@qpall.com
- ITALIË**  
⑨ **CMP SRL**  
Via Revello 38  
12037 - Saluzzo - CN  
Italië  
Telefoon: +39 175 217560  
E-mail: italy@qpall.com
- NEDERLAND**  
⑩ **Q-PALL BV HQ**  
Taylorweg 2  
NL-5466 AE Veghel  
Nederland  
Telefoon: +31 413 353 111  
E-mail: info@qpall.com
- NOORWEGEN**  
⑪ **STROMBERGS PLAST AS**  
Postboks 3  
Stallbakken 7  
NO-2005 Raelingen  
Noorwegen  
Telefoon: +47 64 80 29 04  
E-mail: norway@qpall.com
- OEKRAÏNE**  
⑫ **OSTTOR PALLETS**  
Rokytyanskiy side street 1  
Chernivtsi  
Oekraïne  
Telefoon: +38 372 58 40 85  
E-mail: info@qpall.com
- OOSTENRIJK**  
⑬ **RUMPL GMBH**  
Schmiedlstraße 15  
8042 Graz  
Oostenrijk  
Telefoon: +43 316 406 460  
E-mail: austria@qpall.com
- PORTUGAL**  
⑭ **CAREPACK - SOLUÇÕES DE EMBALAGEM, LDA.**  
Z.I. do Canhestro, R. do Casalinho  
Armazém 1C - Pousos  
2410-478 Leiria  
Portugal  
Telefoon: +351 244 095 210  
E-mail: portugal@qpall.com
- ROEMENIË**  
⑮ **LOGISTIC PACKAGING SRL**  
29 Drumul Sariei, Etaj 2  
060152, Bucharest  
Roemenië  
Telefoon: +4 021 202 32 38  
E-mail: info@qpall.com
- SLOVENIË**  
⑯ **TRICOR D.O.O.**  
SV. Lenart 17  
SLO-4227 Selca  
Slovenië  
Telefoon: + 386 4 257 56 80  
E-mail: info@qpall.com
- SPANJE**  
⑰ **OSONA INDUSTRIAL PLASTICS, S.L.**  
Carrer Font del buc, 9  
PAE Ca l'Avellanet  
08554 Sant Miquel de Balenyà  
**SPANJE**  
Telefoon: +34 93 812 41 96  
E-mail: spain@qpall.com
- TSJECHISCHE REPUBLIEK - SLOWAKIJE**  
⑱ **GREEN PLANET INVESTMENT, S.R.O.**  
Company Head Office:  
Piletická 61/36a  
Hradec Králové  
500 03 Tsjechische Republiek  
Telefoon: +420 603 472 169  
E-mail: czechia@qpall.com
- TURKIJE**  
⑲ **PDA IC VE DIS TICARET LTD. STI.**  
Bahri Saritepe Cad. No:51/3  
45030 Yunusemre Manisa  
**TURKIJE**  
Telefoon: +90 236 2362022  
E-mail: turkey@qpall.com
- VERENIGD KONINKRIJK**  
⑳ **ALL PALLETS LTD**  
Unit 6b, Alder Close,  
Eastbourne, East Sussex  
England BN23 6QF  
Telefoon: +44 1323 744057  
E-mail: uk@qpall.com
- VERENIGDE STATEN**  
㉑ **THE NELSON COMPANY**  
4517 North Point Blvd  
Baltimore, MD 21219  
Verenigde Staten  
Telefoon: +1 410 477 3000  
E-mail: us@qpall.com
- ㉒ **TRANPAK**  
2860 S. East Ave.  
Fresno, CA 93725-1909  
Verenigde Staten  
Telefoon: +1 800 827 2474  
E-mail: us@qpall.com
- ZWITSERLAND**  
㉓ **DYNAMEX**  
Gewerbestr. 2,  
8475 Ossingen  
Zwitserland  
Telefoon: +41 52 305 20 41  
E-mail: switzerland@qpall.com
- ZWEDEN**  
㉔ **TOFO TRADING AB**  
Tegelvägen 4  
SE-382 82 NYBRO  
Zweden  
Telefoon: +46 481 140 17  
E-mail: sweden@qpall.com

## PRODUCTIELOCATIES

### NEDERLAND

① Balk

### DUITSLAND

② Ringe

③ Marktoberdorf

### DENEMARKEN

④ Ribe

### Frankrijk

⑤ Nantes

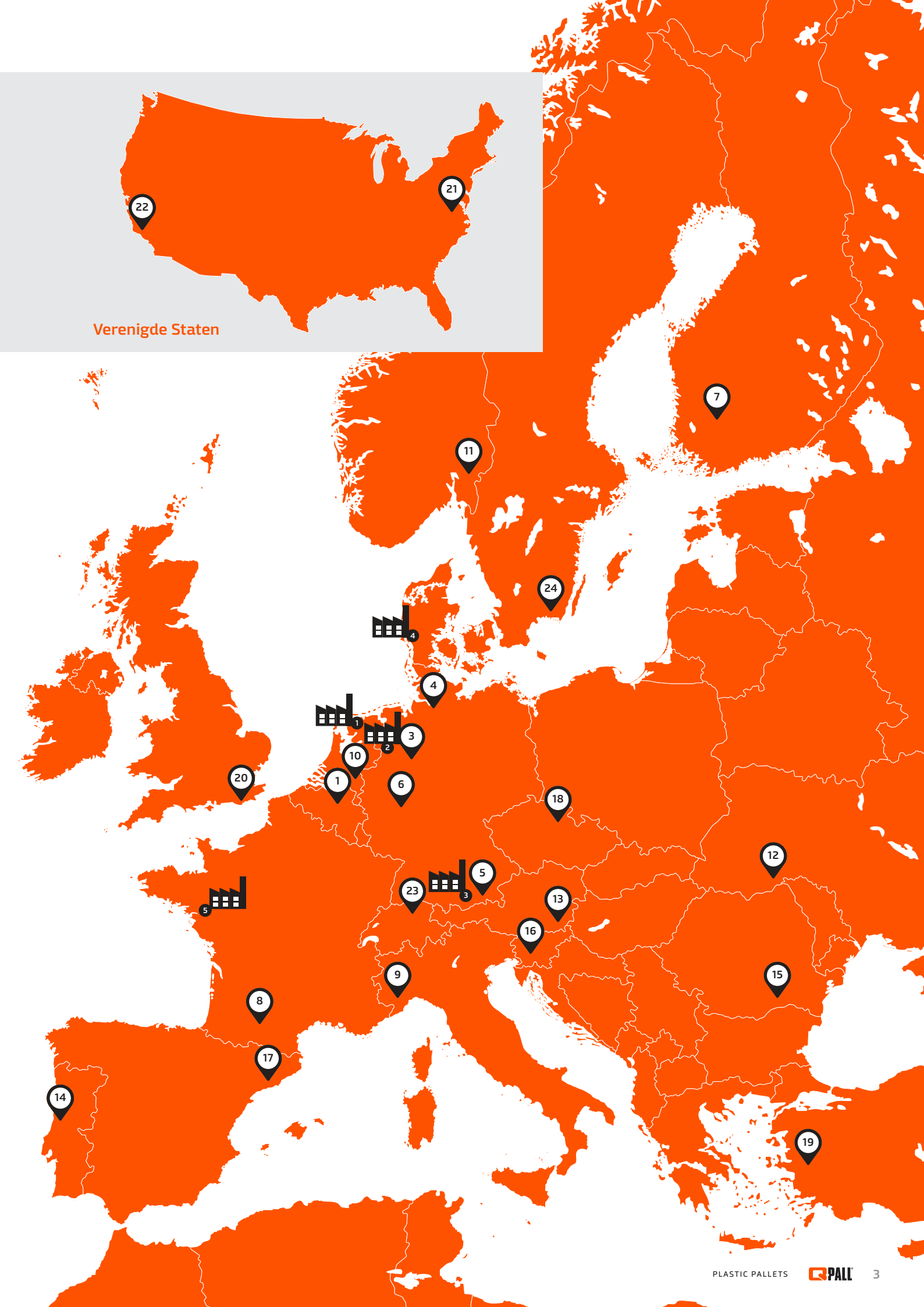
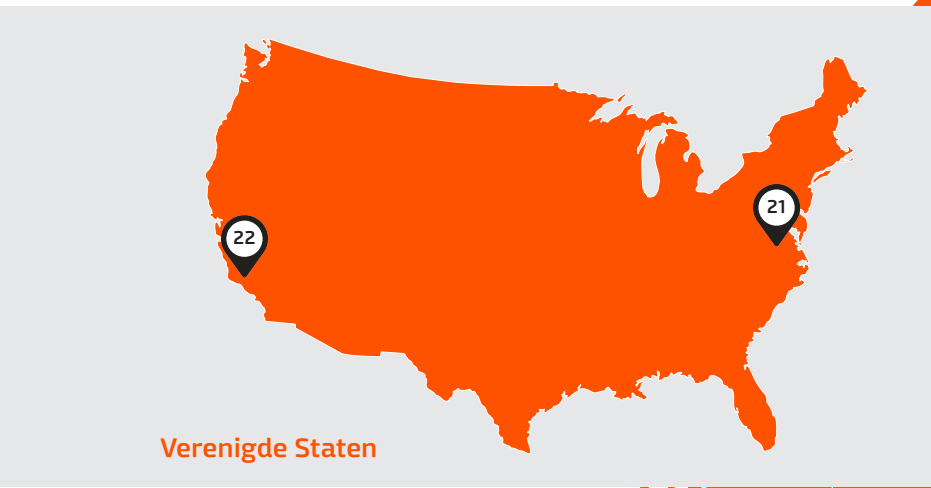



# INHOUDSOPGAVE

The Orange Values	6
Onze inzet voor CO <sub>2</sub> -reductie	8
Act global produce local	10
Onze inspanning voor het hergebruiken van plastic	12
Ons geloof in het optimaliseren van kosten en milieuprestaties	14
Belasting van pallets	16
Testen van de palletstelling belasting (Racking load)	18
Terminologie	20
Materiaal	22
<b>Onze producten</b>	<b>28</b>
<b>Kunststof pallets</b>	
400 x 600 mm	30
600 x 800 mm	34
760 x 1140 mm	42
800 x 1200 mm	48
900 x 1200 mm	58
1000 x 1200 mm	64
1020 x 1220 mm	82
1100 x 1100 mm	88
1100 x 1300 mm	94
1140 x 1140 mm	102
1200 x 1200 mm	110
<b>Specials</b>	<b>118</b>
Kunststof opzetranden en deksels	120
Bottleguard	122
Freezer spacers	124
Kunststof lekbak	126



# PALLETS WITH A PURPOSE

De keuze voor kunststof pallets is inmiddels een logische, die voortvloeit uit uw wens voor duurzaamheid, kostenefficiëntie en milieutechnische overwegingen. De keuze voor Q-PALL als uw partner daarin, is ook een logische, die samenhangt met uw behoefte aan een innovatieve fabrikant met een eigen gedachtegoed.

## The Orange Values

Een bedrijf dat door het beheersen van de gehele keten - productie, distributie en verkoop - als geen ander de technische en logistieke condities kan bieden die ook binnen uw onderneming bijdragen aan optimale bedrijfsvoering.

Daarnaast heeft iedere onderneming te maken met duurzame uitdagingen: productiekosten verlagen, minder grondstoffen gebruiken en duurzame producten op de markt brengen. Dit hebben wij samengevat in onze Orange Values.



De uitstoot van CO<sub>2</sub>-gassen draagt direct bij aan klimaatverandering en daarmee aan de opwarming van de aarde en het stijgen van de waterspiegel. De complexe gevolgen hiervan brengen uitdagingen met zich mee voor hele gemeenschappen, landbouw en de beschikbaarheid van ruwe grondstoffen. Een gedeelde verantwoordelijkheid waar we samen oplossingen voor moeten zien te vinden.

## Onze inzet voor CO<sub>2</sub>-reductie

Q-PALL draagt hieraan een steentje bij. Binnen de industrie waarin we werkzaam zijn promoten we een zo efficiënt mogelijk energiegebruik, om daarmee zowel de CO<sub>2</sub>-uitstoot als de kosten te reduceren. We focussen ons daarbij op het transport, omdat daar de grootste winst te behalen valt. Het transport van plastic pallets is namelijk voor meer dan 80% verantwoordelijk voor de CO<sub>2</sub>-uitstoot van deze industrie.

Ons oorspronkelijke doel voor 2020 was om naast een groei in volume de CO<sub>2</sub>-uitstoot per verplaatst pallet met 60% te reduceren.

Vandaag de dag worden onze pallets geproduceerd op de plaats waar ze nodig zijn door de mal te verplaatsen naar de dichtstbijzijnde Europese productielocatie. Door dit efficiënte systeem worden de CO<sub>2</sub>-uitstoot en de kosten van transport tot een minimum beperkt. Aan het eind van de levensloop wordt het materiaal van onze producten bovendien hergebruikt. Zo minimaliseren we de CO<sub>2</sub>-reductie van Q-PALL pallets bij alle stappen van het proces, van productie tot recycling.

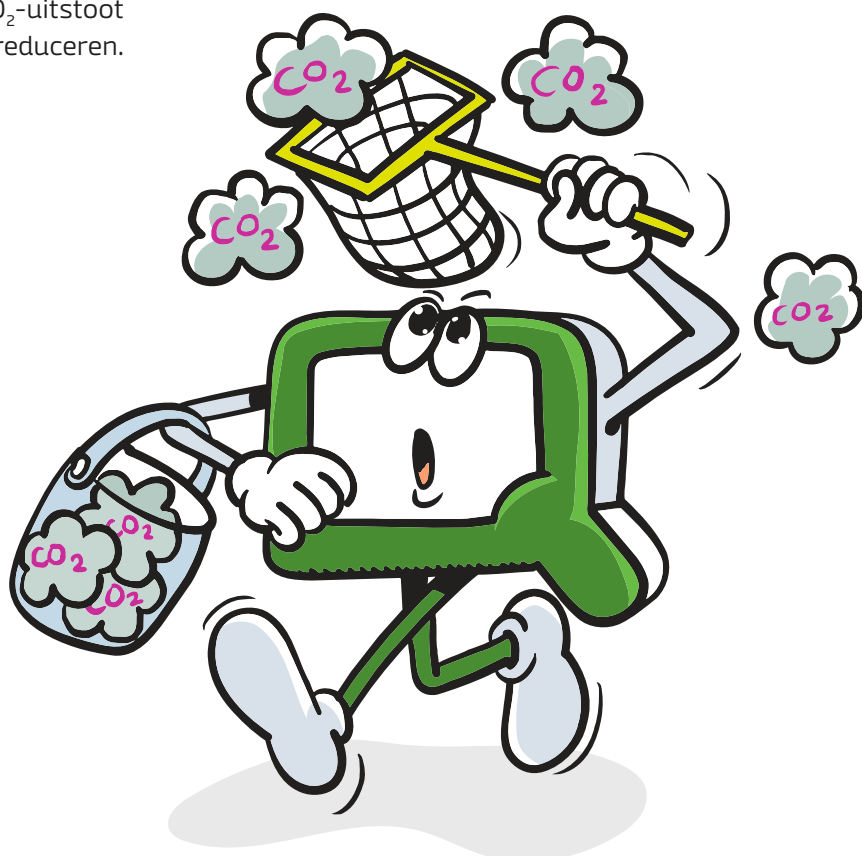



PALLETS WITH

A PURPOSE



ACT

GLOBAL

PRODUCE

LOCAL

TRADITIONNEEL

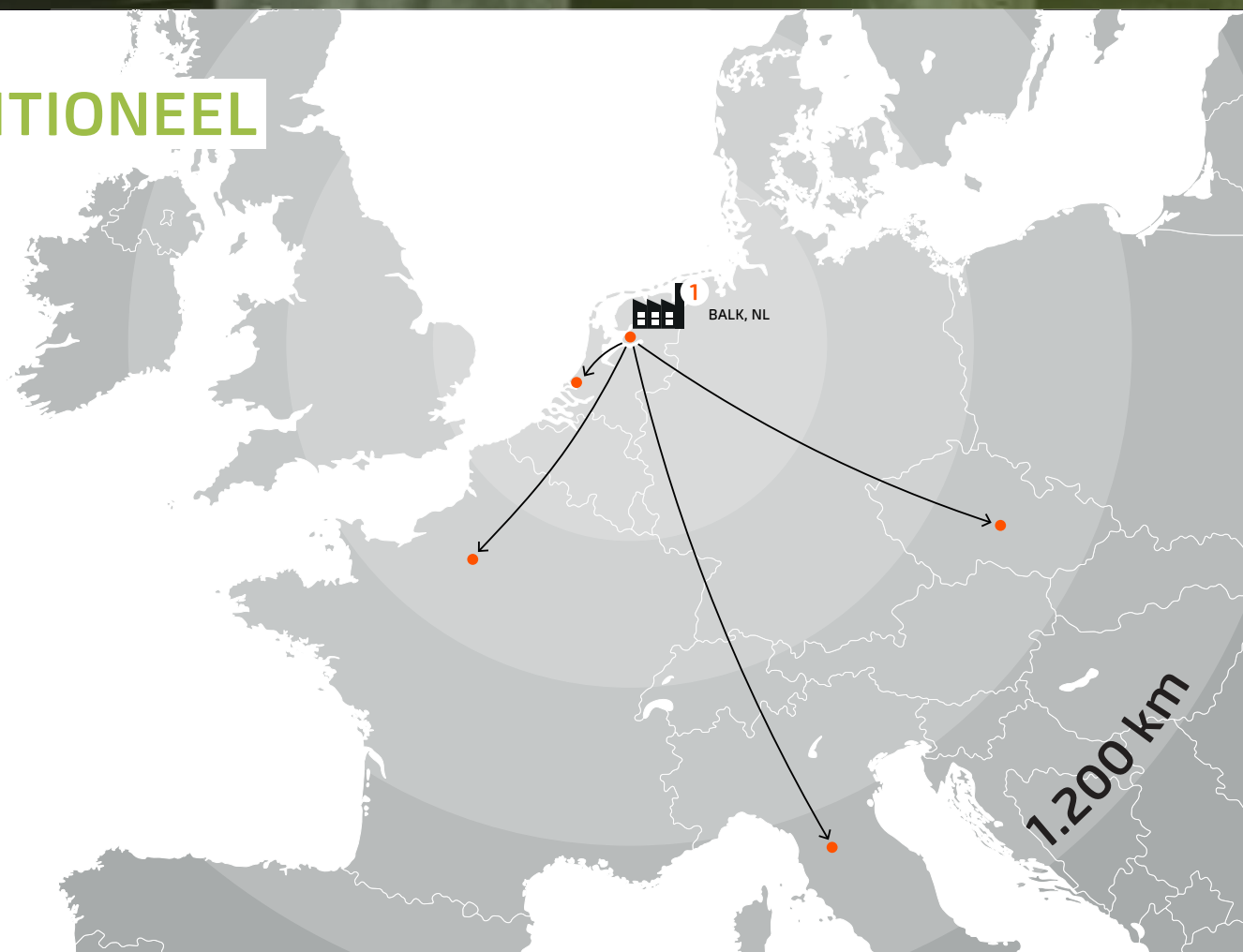

Gemiddelde besparing bij het transporteren van de matrijs in plaats van van pallets:

 100.000 pallets

 CO<sub>2</sub> 136.700 kg 

 100.000 km 

## DE Q-PALL MANIER





# PALLETS WITH A PURPOSE

We leven in een plastic tijdperk, waarin wereldwijd jaarlijks meer dan 300 miljoen ton plastic wordt geproduceerd. 5 tot 15 miljoen ton daarvan belandt in onze oceanen, waar de 'plastic soep' een serieus problematische vorm aanneemt. Plastic is een belangrijk materiaal in de huidige wereldeconomie. Het gebrek aan het verzamelen, hergebruiken, recyclen en afbreken ervan heeft echter verstrekende gevolgen op het gebied van milieu, gezondheid, economie en samenleving. Nietsdoen is geen optie. Wereldwijd begint het besef te groeien dat we dit probleem moeten aanpakken en de plaats van plastic en plastic verpakkingen in onze economie moeten heroverwegen.

## Onze inspanning voor het hergebruiken van plastic

Bij Q-PALL doen we dat door recycling. Bij de oprichting was ons doel om 90% van het plastic te hergebruiken. Vandaag de dag wordt 98% van de pallets gemaakt van gerecycled materiaal. Daarnaast zetten we ons in voor een betere toekomst door projecten te steunen die betrokkenheid creëren bij het plastic afvalprobleem. Allemaal gebruiken we plastic, maar kan dat minder? En wat kunnen we doen met het plastic afval en hoe kunnen we voorkomen dat het in de rivieren en de oceanen terecht komt. En daarom help het als we minder plastic produceren en gebruiken en meer plastic recyclen.

*"We hoeven niet meer plastic te produceren als we gebruiken wat er al is."*

*Bjorn Oosterhof - Q-PALL*

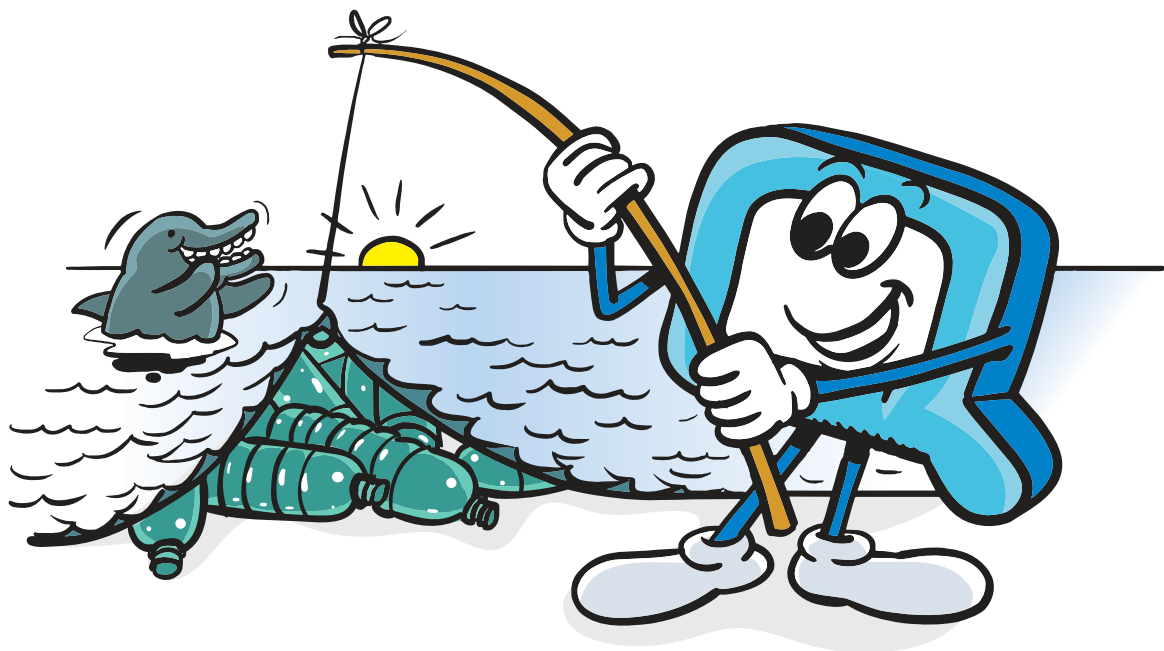



**PALLETS WITH**

**A PURPOSE**

Bespaar, optimaliseer en reduceer. Of het nu gaat om water of energieverbruik, Materialen, CO2-uitstoot of afval; ons bedrijf heeft veel te winnen. Naast de gebruikelijke criteria als prijs-kwaliteit wordt de ecologische voetafdruk een steeds belangrijker punt in de overweging van onze klanten. Environmental Product Declaration (EPD) documenten zijn beschikbaar voor alle typen plastic pallets. Bij Q-PALL houden we de onderzoeken naar de ecologische voetafdruk dan ook nauwlettend in de gaten. De uitkomsten hiervan vormen de basis voor het verder verbeteren van de milieuvriendelijkheid van onze producten. We blijven zoeken naar manieren om de uitstoot van broeikasgassen te minimaliseren. Dat doen we door met strenge designdoelstellingen de lat hoog te leggen op het gebied van energie- en materiaalefficiëntie.

## Ons geloof in het optimaliseren van kosten en milieuprestaties

Onze ingenieurs werken voortdurend aan het verbeteren en uitbreiden van ons assortiment plastic pallets. De focus ligt daarbij op lichtgewicht design, minder opbrengstverlies en het (her) gebruik van onderdelen en productieschroot. De innovatieve concepten en producten zijn erop gericht onze klanten aan de top te houden. Daarom ontwerpen we vaak in overleg en kunnen we met de plastic pallets tegemoetkomen aan de meest specifieke wensen. Als producent en leverancier is Q-Pall zelfs een van de marktleiders op het gebied van maatwerk plastic pallets. De vele voordelen van onze plastic pallets maken dit logistieke hulpstuk beter in vrijwel elk opzicht.

*“We blijven zoeken naar manieren om de uitstoot van CO2 te minimaliseren. We doen dit door de lat hoog te leggen in termen van het minimaliseren van energie en materiaal gebruik in Jumbo trailernatie met strikte ontwerpdoelen.”*

*Arno Putters - Q-PALL*



# BELASTING VAN PALLETS

Palletstelling belasting, statische belasting en dynamische belasting  
Wat is dat precies? Deze vraag krijgen we vaak. Hieronder gegeven we een korte uitleg met een illustratie.

## PALLETSTELLING BELASTING

Wordt ook wel 'Palletstelling laadcapaciteit' genoemd en is de maximale belasting van een pallet in een Palletstelling zonder inlegborden bij een gelijkmatig verdeelde belasting van de pallet. De pallets worden getest met een gelijkmatig verdeelde belasting met zakken van 25 kg.



\* Onze tests zijn gebaseerd op bovenstaande palletstelling.



## STATISCHE BELASTING

De statische belasting (statisch laadcapaciteit) is de maximale belasting van een pallet als deze op een vlakke ondergrond staat. Indien er meerdere pallets gestapeld zijn, is het totale gewicht bepalend voor de belasting op de onderste pallet.



## DYNAMISCHE BELASTING

De dynamische belasting (dynamisch laadcapaciteit) is de maximale belasting van een pallet tijdens het transport met een vorkheftruck of pompwagen bij een gelijkmatig verdeelde belasting van de pallet.

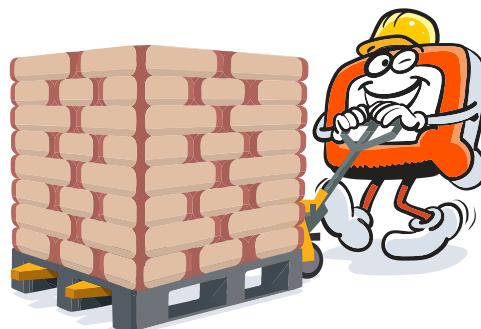

# TESTEN VAN DE PALLETSTELLING BELASTING (RACKING LOAD)

Vorbereiding van de test/vereisten:  
de pallets worden geplaatst op  
twee balken (50 mm) met een  
ruimte tussen de twee balken  
van 100 cm. De metingen worden  
op verschillende tijdstippen op  
verschillende plaatsen op de pallet  
uitgevoerd. De pallet wordt geladen  
met zakken van 25 kg.

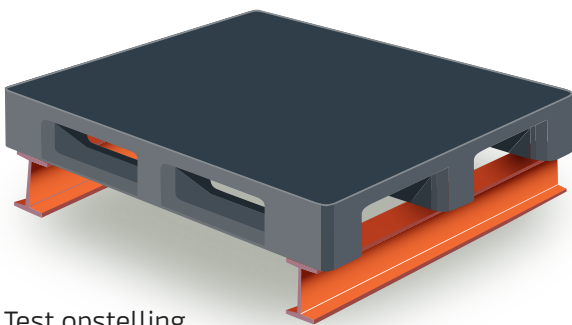

Test opstelling

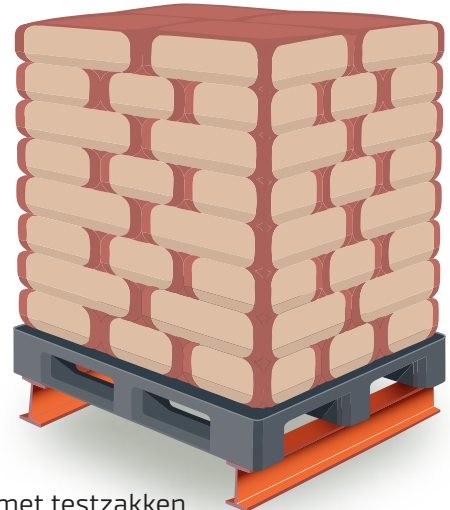

Geladen met testzakken

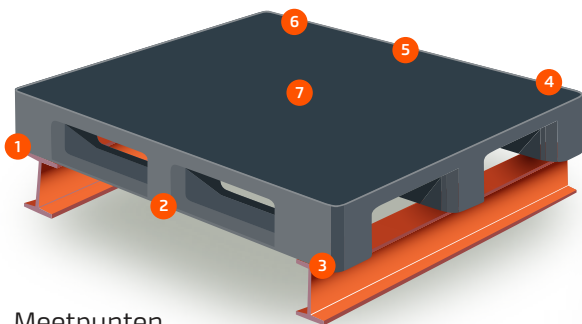

Meetpunten

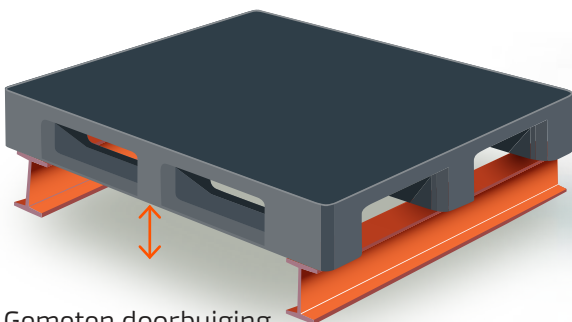

Gemeten doorbuiging



Palletstelling

# “EEN GOED PRODUCT IS ÉÉN DING, GOEDE SERVICE IS MINSTENS ZO BELANGRIJK!”

“Een pallet is typisch zo'n product wat erbij hoort en waar je verder niet te veel over na wilt denken. Dat laten we dan ook graag aan Q-PALL over. In hun brede assortiment pallets vinden we eigenlijk altijd wat we nodig hebben, zeker met het advies dat Q-PALL geeft. Je ziet dat ze goed nadenken over hun producten en deze waar mogelijk verder verbeteren. Maar een goed product is één ding, voor ons is service nog veel belangrijker. Wij hebben vaak op korte termijn veel pallets nodig. Juist de snelle levering en het meedenken is voor ons de reden om elke keer weer voor Q-PALL te kiezen.”



Jim Hardisty, Dealer  
Verenigd Koninkrijk (All Pallets)



# TERMINOLOGIE



Rand



Zonder rand



Stapelnok



3 onderlatten



4 pootjes  
nestbaar



5 onderlatten



6 pootjes  
nestbaar



6 onderlatten



9 pootjes  
nestbaar



RAL-kleur



Klikbare onderlat



Foliehaak



Klantspecifieke  
markering



Anti-slip

Ole Jørgensen,  
Dealer Denemarken (Dansk Transport Emballage)

**“MILIEUBEWUST  
ÉN GOED VOOR DE  
PORTEMONNEE,  
VOOR ONS  
DE IDEALE JUMBO  
TRAILERNATIE.”**

“Duurzaamheid is belangrijk voor de consument. Voor ons als bedrijf wordt het steeds belangrijker om ook de keuze van onze leveranciers te kunnen verantwoorden naar onze klant. Je zit daarbij vrijwel altijd in een spagaat, omdat groener vaak ook duurder betekent. Dat Q-PALL een manier heeft gevonden waarbij milieubewust en goed voor de portemonnee samengaan, is voor ons dan ook de ideale Jumbo trailernatie. Productie op de plek van afname en daarmee besparen op transport, met als gevolg minder CO<sub>2</sub>-uitstoot en transportkosten: briljant!”



# MATERIAAL

## EENMALIGE PALLET

### BUDGET

De pallets voor eenmalig gebruik zijn gemaakt van het eersteklas mixmateriaal PE (gerecycled polyethyleen) en PP (polypropyleen). Het materiaal is vooral geschikt voor pallets: een kwaliteitsmateriaal voor een optimale verhouding tussen gewicht en sterkte.

De producten worden vaak en met succes gebruikt als exportpallets. Omdat ze zo solide zijn, kunt u uw goederen veilig verzenden. Met deze innovatieve pallets worden de geuren van zendingen niet aangetast en kunnen de batches comfortabel en zonder hinder van geuren worden verwerkt.

## MEERMALIGE PALLET

### REGULAR

De meermalige pallets van Mix HDPE zijn uitermate geschikt voor langdurig en frequent gebruik. HDPE staat bekend om zijn grote sterkte / dichtheidsverhouding. Hoewel de dichtheid van HDPE slechts marginaal hoger is dan die van polyethyleen met lage dichtheid (LDPE), heeft HDPE betere intermoleculaire bindingen en treksterkte dan LDPE. Het verschil in sterkte overschrijdt het verschil in dichtheid, waardoor HDPE een hogere specifieke sterkte krijgt.

## POOLPALLET

### PREMIUM

Alle pallets kunnen ook worden gemaakt van nieuw materiaal PPC (polypropyleencarbonaat). PPC heeft daardoor een homogenere samenstelling en is daarom steviger en duurzamer. In de premiumlijn vindt u kwalitatief hoogwaardige pallets die zeer lang meegaan. De pallets kunnen goed worden ingezet binnen uw eigen bedrijf of in een palletpool tussen verschillende bedrijfsvestigingen en klanten.



**Alle pallets zijn  
100% recyclebaar**

# Q-CARE

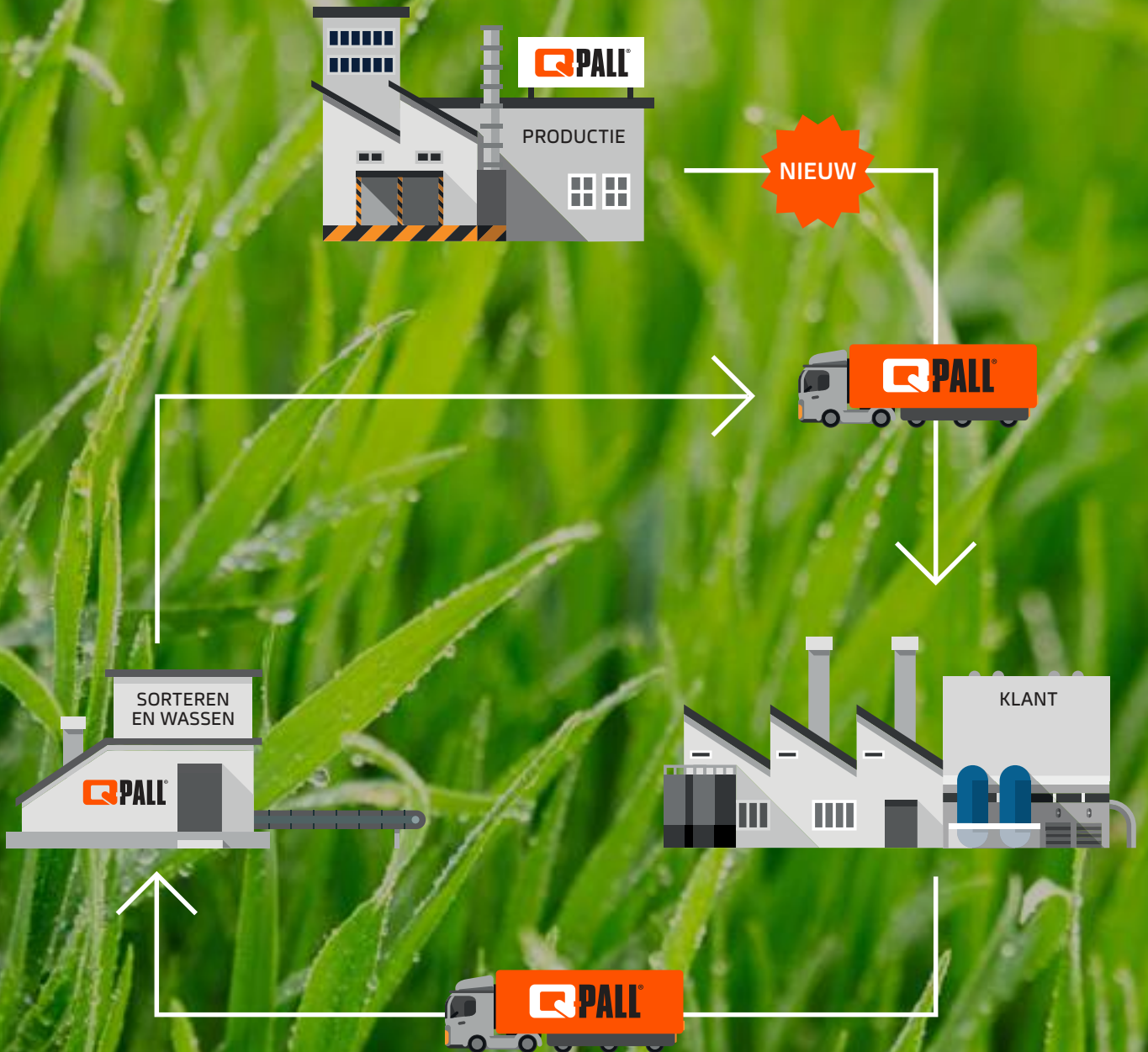





Thierry Pautonnier,  
Dealer Frankrijk (Bacland Pack)

**"BIED ELKE  
KLANT  
PRECIES DE  
PRODUCTEN  
DIE ZE NODIG  
HEBBEN!"**

"We werken al jaren prettig samen met Q-PALL. Frankrijk is een belangrijke economische kracht, met belangen die over de hele wereld verspreid zijn, over de meeste belangrijke industriële sectoren.

Elk industrieel segment stelt zijn eigen eisen. Daarom kijken we samen naar de specifieke uitdagingen van onze klanten en bieden we iedereen precies de producten die ze nodig hebben voor hun dagelijkse werk. Naast standaardproducten ontwikkelen ze ook op maat gemaakte pallets, zodat Q-Pall-producten altijd aan hun behoeften voldoen."



# ONZE PALLETS ZIJN VAN ALLE MARKTEN THUIS

De wereldeconomie biedt plaats aan een breed scala industrieën zoals de farmaceutische, automotieve en levensmiddelenindustrie. Transport, distributie en opslag spelen in al die markten een belangrijke rol, net als de pallets die dit mogelijk maken. Q-PALL is als producent en leverancier van kunststof pallets helemaal op de hoogte van de specifieke eisen die uw industrie stelt aan onze producten. Daarom leggen we de lat hoog. We blijven investeren in kwaliteit, duurzaamheid en kostenefficiëntie. Zo kunnen we u niet alleen vandaag, maar ook in de toekomst op uw wenken bedienen.



# RETAIL & SUPERMARKT

De producten in deze industrie lopen uiteen van levensmiddelen tot non-food producten als kleding en elektronica. Retail en supermarkt vormen de laatste distributieschakel tussen winkel en consument. Het is belangrijk dat het transport zo soepel mogelijk verloopt, met zo min mogelijk beschadigingen. Q-PALL biedt pasklare oplossingen voor de uiteenlopende producten: van verzegelbare pallets tot pallets die volledig geschikt zijn voor geautomatiseerde orderpicking- en handlingsystemen.



The background of the image shows a close-up of industrial machinery, likely a plastic pallet mold. A large, light-colored metal plate is visible, along with various mechanical components, pipes, and a complex grid structure that forms the mold for the pallet. The lighting is warm and focused on the machinery.

# ONZE PRODUCTEN



# ONZE PRODUCTEN

# 400 X 600 MM



# 400 X 600 MM MEDIUM/HEAVY

L	Light pallet
M	Medium pallet
H	Heavy pallet
↕	Meermalige pallet
→	Eenmalige pallet



## MEDIUM

### SPECIFICATIES

ARTIKEL	ONDERDEK	GEBRUIK	RAND	BOVENDEK	AFMETINGEN			LAADCAPACITEIT			
					LENGTE	BREEDTE	HOOGTE	STATISCH	DYNAMISCH	PALLETSTELLING	GEWICHT
QP6040MR4F	4 pootjes nestbaar	meermalig	-	open	600	400	155	500	200	0	2,05

### VRACHTLADINGEN

ARTIKEL	STANDAARD TRUCK*		JUMBO TRAILER*		20' HC CONTAINER*		40' HC CONTAINER*	
	STAPEL	TOTAAL	STAPEL	TOTAAL	STAPEL	TOTAAL	STAPEL	TOTAAL
QP6040MR4F	200	5200	200	6000	200	2000	200	4200

\* Standaard truck: 13.60 x 2.44 - 2.48 x 2.65 m (L x b x h) / Jumbo trailer: 7.60-7.60 x 2.45 x 3.00 m (L x b x h) / 20'HC (binnenmaat): 5.90 x 2.35 x 2.70 m (L x b x h) / 40' HC (binnenmaat): 12.00 x 2.35 x 2.70 m (L x b x h)

## HEAVY

### SPECIFICATIES

ARTIKEL	ONDERDEK	GEBRUIK	RAND	BOVENDEK	AFMETINGEN			LAADCAPACITEIT			
					LENGTE	BREEDTE	HOOGTE	STATISCH	DYNAMISCH	PALLETSTELLING	GEWICHT
QP6040HR4F	4 pootjes nestbaar	meermalig	-	open	600	400	155	750	500	0	2,05

### VRACHTLADINGEN

ARTIKEL	STANDAARD TRUCK*		JUMBO TRAILER*		20' HC CONTAINER*		40' HC CONTAINER*	
	STAPEL	TOTAAL	STAPEL	TOTAAL	STAPEL	TOTAAL	STAPEL	TOTAAL
QP6040HR4F	200	5200	200	6000	200	2000	200	4200

\* Standaard truck: 13.60 x 2.44 - 2.48 x 2.65 m (L x b x h) / Jumbo trailer: 7.60-7.60 x 2.45 x 3.00 m (L x b x h) / 20'HC (binnenmaat): 5.90 x 2.35 x 2.70 m (L x b x h) / 40' HC (binnenmaat): 12.00 x 2.35 x 2.70 m (L x b x h)





QP6040MR4F



QP6040MR4F

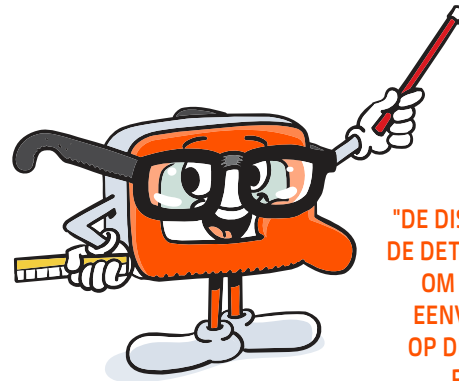

"DE DISPLAY PALLET STELT DE DETAILHANDEL IN STAAT OM HUN PRODUCTEN EENVOUDIG EN DIRECT OP DE WINKELVLOER TE PRESENTEREN"

### BESCHIKBARE OPTIES



ESD



ANTI-SLIP



BEDRUKKING MET LOGO OF TEKST



BRANDVERTRAGEND



RAL-KLEUR



QP6040HR4F



QP6040HR4F



QP6040HR4F







**ONZE PRODUCTEN**

**600 X 800 MM**

# 600 X 800 MM LIGHT

L	Light pallet
M	Medium pallet
H	Heavy pallet
↕	Meermalige pallet
→	Eenmalige pallet



QP6080LR3RR



## SPECIFICATIES

ARTIKEL	ONDERDEK	GEBRUIK	RAND	BOVENDEK	AFMETINGEN			LAADCAPACITEIT			GEWICHT
					LENGTE	BREEDTE	HOOGTE	STATISCH	DYNAMISCH	PALLETSTELLING	
QP6080LR3R	3 onderlatten	meermalig	-	open	800	600	145	500	350	0	2,66
QP6080LR3RR	3 onderlatten	meermalig	✓	open	800	600	145	500	350	0	2,66

## VRACHTLADINGEN

ARTIKEL	STANDAARD TRUCK*		JUMBO TRAILER*		20' HC CONTAINER*		40' HC CONTAINER*	
	STAPEL	TOTAAL	STAPEL	TOTAAL	STAPEL	TOTAAL	STAPEL	TOTAAL
QP6080LR3R	100	3300	100	3800	100	1100	100	2500
QP6080LR3RR	100	3300	100	3800	100	1100	100	2500

\* Standaard truck: 13.60 x 2.44 - 2.48 x 2.65 m (L x b x h) / Jumbo trailer: 7.60-7.60 x 2.45 x 3.00 m (L x b x h) / 20' HC (binnenmaat): 5.90 x 2.35 x 2.70 m (L x b x h) / 40' HC (binnenmaat): 12.00 x 2.35 x 2.70 m (L x b x h)



QP6080LR3RR



QP6080LR3RR



600 x 800 mm

"VOOR TRANSPORT VAN  
KLEINE ZENDINGEN.  
OOK GESCHIKT VOOR DE  
OPSLAG VAN BANDEN"



### BESCHIKBARE OPTIES



ESD



ANTI-SLIP



BEDRUKKING MET LOGO OF TEKST



BRANDVERTRAGEND



RAL-KLEUR



# 600 X 800 MM MEDIUM

L	Light pallet
M	Medium pallet
H	Heavy pallet
↕	Meermalige pallet
→	Eenmalige pallet



QP6080MR6FR



## SPECIFICATIES

ARTIKEL	ONDERDEK	GEBRUIK	RAND	BOVENDEK	AFMETINGEN			LAADCAPACITEIT			GEWICHT
					LENGTE	BREEDTE	HOOGTE	STATISCH	DYNAMISCH	PALLETSTELLING	
QP6080MR6F	6 pootjes nestbaar	meermalig	-	open	800	600	143	1000	500	0	3,14
QP6080MR6FR	6 pootjes nestbaar	meermalig	✓	open	800	600	143	1000	500	0	3,14
QP6080MR3R	3 onderlatten	meermalig	-	open	800	600	143	1000	500	0	3,65
QP6080MR3RR	3 onderlatten	meermalig	✓	open	800	600	143	1000	500	0	3,65

## VRACHTLADINGEN

ARTIKEL	STANDAARD TRUCK*		JUMBO TRAILER*		20' HC CONTAINER*		40' HC CONTAINER*	
	STAPEL	TOTAAL	STAPEL	TOTAAL	STAPEL	TOTAAL	STAPEL	TOTAAL
QP6080MR6F	80	2640	80	3040	80	880	80	2000
QP6080MR6FR	80	2640	80	3040	80	880	80	2000
QP6080MR3R	36	1188	40	1520	36	396	36	900
QP6080MR3RR	36	1188	40	1520	36	396	36	900

\* Standaard truck: 13.60 x 2.44 - 2.48 x 2.65 m (L x b x h) / Jumbo trailer: 7.60-7.60 x 2.45 x 3.00 m (L x b x h) / 20' HC (binnenmaat): 5.90 x 2.35 x 2.70 m (L x b x h) / 40' HC (binnenmaat): 12.00 x 2.35 x 2.70 m (L x b x h)



QP6080MR6FR



QP6080MR6FR

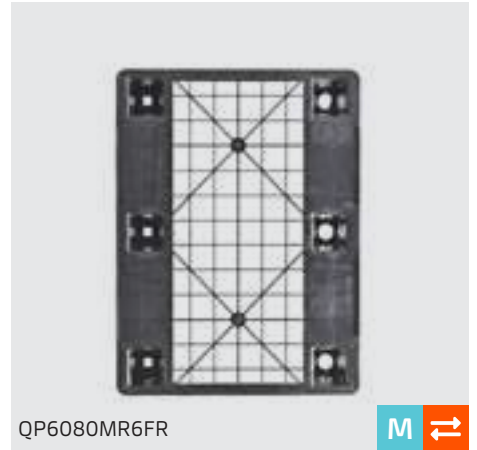

QP6080MR6FR



### BESCHIKBARE OPTIES



BRANDVERTRAGEND



RAL-KLEUR



QP6080MR3RR



QP6080MR3RR



# 600 X 800 MM HEAVY

L	Light pallet
M	Medium pallet
H	Heavy pallet
↕	Meermalige pallet
→	Eenmalige pallet



QP6080HR6FR



## SPECIFICATIES

ARTIKEL	ONDERDEK	GEBRUIK	RAND	BOVENDEK	AFMETINGEN			LAADCAPACITEIT			GEWICHT
					LENGTE	BREEDTE	HOOGTE	STATISCH	DYNAMISCH	PALLETSTELLING	
QP6080HB6F	6 pootjes nestbaar	eenmalig	-	open	800	600	155	1000	600	0	5,50
QP6080HB6FR	6 pootjes nestbaar	eenmalig	✓	open	800	600	155	1000	600	0	5,50
QP6080HR6F	6 pootjes nestbaar	meermalig	-	open	800	600	155	1000	600	0	5,76
QP6080HR6FR	6 pootjes nestbaar	meermalig	✓	open	800	600	155	1000	600	0	5,76

## VRACHTLADINGEN

ARTIKEL	STANDAARD TRUCK*		JUMBO TRAILER*		20' HC CONTAINER*		40' HC CONTAINER*	
	STAPEL	TOTAAL	STAPEL	TOTAAL	STAPEL	TOTAAL	STAPEL	TOTAAL
QP6080HB6F	70	2310	80	3040	80	880	80	2000
QP6080HB6FR	70	2310	80	3040	80	880	80	2000
QP6080HR6F	70	2310	80	3040	80	880	80	2000
QP6080HR6FR	70	2310	80	3040	80	880	80	2000

\* Standaard truck: 13.60 x 2.44 - 2.48 x 2.65 m (L x b x h) / Jumbo trailer: 7.60-7.60 x 2.45 x 3.00 m (L x b x h) / 20' HC (binnenmaat): 5.90 x 2.35 x 2.70 m (L x b x h) / 40' HC (binnenmaat): 12.00 x 2.35 x 2.70 m (L x b x h)





**BESCHIKBARE OPTIES**

-  ESD
-  BRANDVERTRAGEND

-  ANTI-SLIP
-  RAL-KLEUR

-  BEDRUKKING MET LOGO OF TEKST





**ONZE PRODUCTEN**

**760 X 1140 MM**



# 760 X 1140 MM LIGHT

L	Light pallet
M	Medium pallet
H	Heavy pallet
↕	Meermalige pallet
→	Eenmalige pallet



QP76114LB9FR



## SPECIFICATIES

ARTIKEL	ONDERDEK	GEBRUIK	RAND	BOVENDEK	AFMETINGEN			LAADCAPACITEIT			
					LENGTE	BREEDTE	HOOGTE	STATISCH	DYNAMISCH	PALLETSTELLING	GEWICHT
QP76114LB9F	9 pootjes nestbaar	eenmalig	-	open	1140	760	150	2500	1000	0	4,6
QP76114LB9FR	9 pootjes nestbaar	eenmalig	✓	open	1140	760	150	2500	1000	0	4,6
QP76114LB9F-CD	9 pootjes nestbaar	eenmalig	-	gesloten	1140	760	150	2500	1000	0	5,7
QP76114LB9FR-CD	9 pootjes nestbaar	eenmalig	✓	gesloten	1140	760	150	2500	1000	0	5,7
QP76114LB3R-CD	3 onderlatten	eenmalig	-	gesloten	1140	760	150	2500	1000	0	7,1
QP76114LB3RR-CD	3 onderlatten	eenmalig	✓	gesloten	1140	760	150	2500	1000	0	7,1
QP76114LB3R	3 onderlatten	eenmalig	-	open	1140	760	150	2500	1000	0	6,0
QP76114LB3RR	3 onderlatten	eenmalig	✓	open	1140	760	150	2500	1000	0	6,0

## VRACHTLADINGEN

ARTIKEL	STANDAARD TRUCK*		JUMBO TRAILER*		20' HC CONTAINER*		40' HC CONTAINER*	
	STAPEL	TOTAAL	STAPEL	TOTAAL	STAPEL	TOTAAL	STAPEL	TOTAAL
QP76114LB9F	48	1584	55	2090	48	528	48	1200
QP76114LB9FR	48	1584	55	2090	48	528	48	1200
QP76114LB9F-CD	48	1584	55	2090	48	528	48	1200
QP76114LB9FR-CD	48	1584	55	2090	48	528	48	1200
QP76114LB3R-CD	16	528	17	646	16	176	16	400
QP76114LB3RR-CD	16	528	17	646	16	176	16	400
QP76114LB3R	16	528	17	646	16	176	16	400
QP76114LB3RR	16	528	17	646	16	176	16	400

\* Standaard truck: 13.60 x 2.44 - 2.48 x 2.65 m (L x b x h) / Jumbo trailer: 7.60-7.60 x 2.45 x 3.00 m (L x b x h) / 20' HC (binnenmaat): 5.90 x 2.35 x 2.70 m (L x b x h) / 40' HC (binnenmaat): 12.00 x 2.35 x 2.70 m (L x b x h)



QP76114LB9FR-CD



QP76114LB9FR



760 x 1140 mm

"OOK BEKEND ALS  
CONTAINER PALLET DIE  
OPTIMAAL GEBRUIK  
MAAKT VAN DE  
BESCHIKBARE RUIMTE"

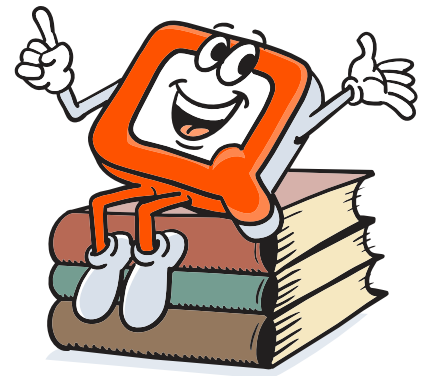

### BESCHIKBARE OPTIES



ESD



ANTI-SLIP



BEDRUKKING MET LOGO OF TEKST



BRANDVERTRAGEND



RAL-KLEUR



QP76114LB3RR-CD



QP76114LB3RR



QP76114LB3RR







# LEVENSMIDDELEN- INDUSTRIE

De levensmiddelendistributie is een voortdurend logistiek proces. Dagelijks worden tienduizenden pallets vervoerd van productie- naar distributie- en verkoopcentra en weer terug. Bij pallets die zo intensief gebruikt worden, wilt u betrouwbaarheid en duurzaamheid voor een zo laag mogelijke prijs. Niet gebruikte pallets moeten zo min mogelijk ruimte innemen. Kunststof pallets zijn in dit geval een logische keuze. Licht, nestbaar, vochtbestendig en duurzaam.



52

49

48





800 x 1200 mm

**ONZE PRODUCTEN**

**800 X 1200 MM**

# 800 X 1200 MM LIGHT

L	Light pallet
M	Medium pallet
H	Heavy pallet
↕	Meermalige pallet
→	Enmalige pallet



QP1208LB3RR



## SPECIFICATIES

ARTIKEL	ONDERDEK	GEBRUIK	RAND	BOVENDEK	AFMETINGEN			LAADCAPACITEIT			GEWICHT
					LENGTE	BREEDTE	HOOGTE	STATISCH	DYNAMISCH	PALLETSTELLING	
QP1208LB9F	9 pootjes nestbaar	eenmalig	-	open	1200	800	150	2500	1000	0	5,12
QP1208LB9FR	9 pootjes nestbaar	eenmalig	✓	open	1200	800	150	2500	1000	0	5,12
QP1208LB9F-CD	9 pootjes nestbaar	eenmalig	-	gesloten	1200	800	150	2500	1000	0	6,17
QP1208LB9FR-CD	9 pootjes nestbaar	eenmalig	✓	gesloten	1200	800	150	2500	1000	0	6,17
QP1208LB3R	3 onderlatten	eenmalig	-	open	1200	800	150	2500	1000	0	6,47
QP1208LB3RR	3 onderlatten	eenmalig	✓	open	1200	800	150	2500	1000	0	6,47
QP1208LB3R-CD	3 onderlatten	eenmalig	-	gesloten	1200	800	150	2500	1000	0	7,52
QP1208LB9RR-CD	3 onderlatten	eenmalig	✓	gesloten	1200	800	150	2500	1000	0	7,52

## VRACHTLADINGEN

ARTIKEL	STANDAARD TRUCK*		JUMBO TRAILER*		20' HC CONTAINER*		40' HC CONTAINER*	
	STAPEL	TOTAAL	STAPEL	TOTAAL	STAPEL	TOTAAL	STAPEL	TOTAAL
QP1208LB9F	48	1584	55	2090	48	528	48	1200
QP1208LB9FR	48	1584	55	2090	48	528	48	1200
QP1208LB9F-CD	48	1584	55	2090	48	528	48	1200
QP1208LB9FR-CD	48	1584	55	2090	48	528	48	1200
QP1208LB3R	16	528	17	646	16	176	16	400
QP1208LB3RR	16	528	17	646	16	176	16	400
QP1208LB3R-CD	16	528	17	646	16	176	16	400
QP1208LB9RR-CD	16	528	17	646	16	176	16	400

\* Standaard truck: 13.60 x 2.44 - 2.48 x 2.65 m (L x b x h) / Jumbo trailer: 7.60-7.60 x 2.45 x 3.00 m (L x b x h) / 20' HC (binnenmaat): 5.90 x 2.35 x 2.70 m (L x b x h) / 40' HC (binnenmaat): 12.00 x 2.35 x 2.70 m (L x b x h)



QP1208LB3RR



QP1208LB3RR-CD



800 x 1200 mm

**BESCHIKBARE OPTIES**



ESD



ANTI-SLIP



BRANDVERTRAGEND



RAL-KLEUR



BEDRUKKING MET LOGO OF TEKST



QP1208LB9FR

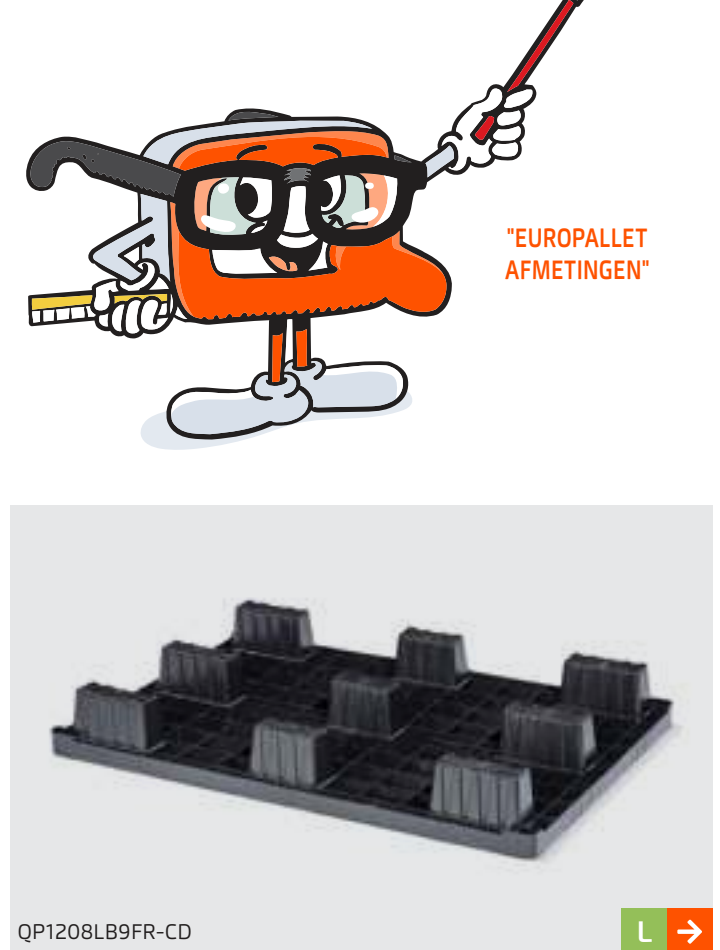

"EUROPALLET  
AFMETINGEN"

QP1208LB9FR-CD



# 800 X 1200 MM MEDIUM

L	Light pallet
M	Medium pallet
H	Heavy pallet
↕	Meermalige pallet
→	Eenmalige pallet

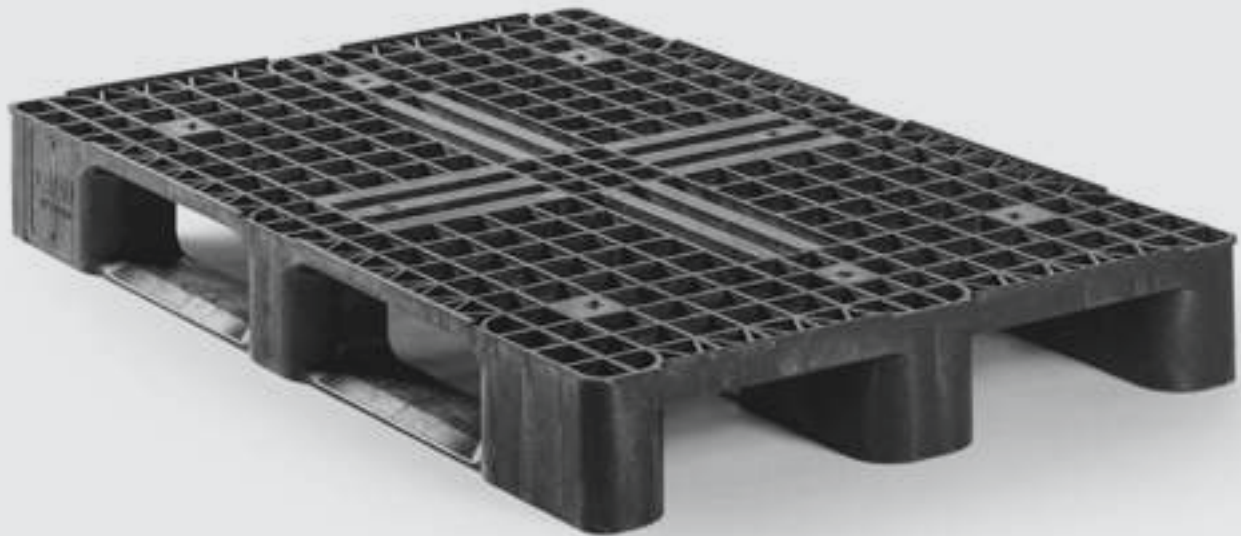

1.QP1208MR3RR



## SPECIFICATIES

ARTIKEL	ONDERDEK	GEBRUIK	RAND	BOVENDEK	AFMETINGEN			LAADCAPACITEIT			GEWICHT
					LENGTE	BREEDTE	HOOGTE	STATISCH	DYNAMISCH	PALLETSTELLING	
1QP1208MB3R	3 onderlatten	eenmalig	-	open	1200	800	145	5000	1250	600	11,66
1QP1208MB3RR	3 onderlatten	eenmalig	✓	open	1200	800	145	5000	1250	600	11,66
1QP1208MR3R	3 onderlatten	meermalig	-	open	1200	800	145	5000	1250	600	11,46
1QP1208MR3RR	3 onderlatten	meermalig	✓	open	1200	800	145	5000	1250	600	11,46

## VRACHTLADINGEN

ARTIKEL	STANDAARD TRUCK*		JUMBO TRAILER*		20' HC CONTAINER*		40' HC CONTAINER*	
	STAPEL	TOTAAL	STAPEL	TOTAAL	STAPEL	TOTAAL	STAPEL	TOTAAL
1QP1208MB3R	17	561	19	722	18	198	18	450
1QP1208MB3RR	17	561	19	722	18	198	18	450
1QP1208MR3R	17	561	19	722	18	198	18	450
1QP1208MR3RR	17	561	19	722	18	198	18	450

\* Standaard truck: 13.60 x 2.44 - 2.48 x 2.65 m (L x b x h) / Jumbo trailer: 7.60-7.60 x 2.45 x 3.00 m (L x b x h) / 20' HC (binnenmaat): 5.90 x 2.35 x 2.70 m (L x b x h) / 40' HC (binnenmaat): 12.00 x 2.35 x 2.70 m (L x b x h)



1.QP1208MR3RR



1.QP1208MR3RR



800 x 1200 mm

### BESCHIKBARE OPTIES



ESD



ANTI-SLIP



BEDRUKKING MET LOGO OF TEKST



BRANDVERTRAGEND



RAL-KLEUR



1.QP1208MR3RR - RAL



# 800 X 1200 MM MEDIUM

L	Light pallet
M	Medium pallet
H	Heavy pallet
↕	Meermalige pallet
→	Enmalige pallet



2.QP1208MR3RR



## SPECIFICATIES

ARTIKEL	ONDERDEK	GEBRUIK	RAND	BOVENDEK	AFMETINGEN			LAADCAPACITEIT			GEWICHT
					LENGTE	BREEDTE	HOOGTE	STATISCH	DYNAMISCH	PALLETSTELLING	
2QP1208MB3R	3 onderlatten	eenmalig	-	open	1200	800	145	5000	1250	500	11,95
2QP1208MB3RR	3 onderlatten	eenmalig	✓	open	1200	800	145	5000	1250	500	11,95
2QP1208MR3R	3 onderlatten	meermalig	-	open	1200	800	145	5000	1250	500	11,79
2QP1208MR3RR	3 onderlatten	meermalig	✓	open	1200	800	145	5000	1250	500	11,79
2QP1208MB3R-CD	3 onderlatten	eenmalig	-	gesloten	1200	800	145	5000	1250	650	13,50
2QP1208MB3RR-CD	3 onderlatten	eenmalig	✓	gesloten	1200	800	145	5000	1250	650	13,50
2QP1208MR3R-CD	3 onderlatten	meermalig	-	gesloten	1200	800	145	5000	1250	650	13,32
2QP1208MR3RR-CD	3 onderlatten	meermalig	✓	gesloten	1200	800	145	5000	1250	650	13,32

## VRACHTLADINGEN

ARTIKEL	STANDAARD TRUCK*		JUMBO TRAILER*		20' HC CONTAINER*		40' HC CONTAINER*	
	STAPEL	TOTAAL	STAPEL	TOTAAL	STAPEL	TOTAAL	STAPEL	TOTAAL
2QP1208MB3R	17	561	19	722	18	198	18	450
2QP1208MB3RR	17	561	19	722	18	198	18	450
2QP1208MR3R	17	561	19	722	18	198	18	450
2QP1208MR3RR	17	561	19	722	18	198	18	450
2QP1208MB3R-CD	17	561	19	722	18	198	18	450
2QP1208MB3RR-CD	17	561	19	722	18	198	18	450
2QP1208MR3R-CD	17	561	19	722	18	198	18	450
2QP1208MR3RR-CD	17	561	19	722	18	198	18	450

\* Standaard truck: 13.60 x 2.44 - 2.48 x 2.65 m (l x b x h) / Jumbo trailer: 7.60-7.60 x 2.45 x 3.00 m (l x b x h) / 20' HC (binnenmaat): 5.90 x 2.35 x 2.70 m (l x b x h) / 40' HC (binnenmaat): 12.00 x 2.35 x 2.70 m (l x b x h)



2.QP1208MR3RR



2.QP1208MR3RR



2.QP1208MR3RR

800 x 1200 mm

**BESCHIKBARE OPTIES**



ESD



ANTI-SLIP



BEDRUKKING MET LOGO OF TEKST



BRANDVERTRAGEND



RAL-KLEUR



QP1208MR3RR-CD



QP1208MR3RR-CD

# 800 X 1200 MM HEAVY

L	Light pallet
M	Medium pallet
H	Heavy pallet
↕	Meermalige pallet
→	Eenmalige pallet



QP1208HR5RR



## SPECIFICATIES

ARTIKEL	ONDERDEK	GEBRUIK	RAND	BOVENDEK	AFMETINGEN			LAADCAPACITEIT			GEWICHT
					LENGTE	BREEDTE	HOOGTE	STATISCH	DYNAMISCH	PALLETSTELLING	
QP1208HB3R	3 onderlatten	eenmalig	-	open	1200	800	156	7500	1750	1000	16,41
QP1208HB3RR	3 onderlatten	eenmalig	✓	open	1200	800	156	7500	1750	1000	16,41
QP1208HR3R	3 onderlatten	meermalig	-	open	1200	800	156	7500	1750	1000	16,35
QP1208HR3RR	3 onderlatten	meermalig	✓	open	1200	800	156	7500	1750	1000	16,35
QP1208HB5R	5 onderlatten	eenmalig	-	open	1200	800	156	7500	1750	1000	17,15
QP1208HB5RR	5 onderlatten	eenmalig	✓	open	1200	800	156	7500	1750	1000	17,15
QP1208HR5R	5 onderlatten	meermalig	-	open	1200	800	156	7500	1750	1000	17,15
QP1208HR5RR	5 onderlatten	meermalig	✓	open	1200	800	156	7500	1750	1000	17,15
EUROPAL800R	3 onderlatten	meermalig	-	gesloten	1200	800	150	5000	1500	750	23,00
EUROPAL800RR	3 onderlatten	meermalig	✓	gesloten	1200	800	150	5000	1500	750	23,00
QPH1208HP3RR-CDG	3 onderlatten	meermalig	✓	gesloten	1200	800	160	7500	1500	1000	18,00
QPH1208HP3RR-CDG*	3 onderlatten	meermalig	✓	gesloten	1200	800	160	7500	1500	1750	18,00

\* With optional reinforcement profiles

## VRACHTLADINGEN

ARTIKEL	STANDAARD TRUCK*		JUMBO TRAILER*		20' HC CONTAINER*		40' HC CONTAINER*	
	STAPEL	TOTAAL	STAPEL	TOTAAL	STAPEL	TOTAAL	STAPEL	TOTAAL
QP1208HB3R	15	495	18	684	17	187	17	425
QP1208HB3RR	15	495	18	684	17	187	17	425
QP1208HR3R	15	495	18	684	17	187	17	425
QP1208HR3RR	15	495	18	684	17	187	17	425
QP1208HB5R	15	495	18	684	17	187	17	425
QP1208HB5RR	15	495	18	684	17	187	17	425
QP1208HR5R	15	495	18	684	17	187	17	425
QP1208HR5RR	15	495	18	684	17	187	17	425
EUROPAL800R	23	598	23	690	18	198	18	450
EUROPAL800RR	23	598	23	690	18	198	18	450
QPH1208HP3RR-CDG	15	495	18	684	18	198	18	450
QPH1208HP3RR-CDG*	15	495	18	684	18	198	18	450

\* Standaard truck: 13.60 x 2.44 - 2.48 x 2.65 m (L x b x h) / Jumbo trailer: 7.60-7.60 x 2.45 x 3.00 m (L x b x h) / 20' HC (binnenmaat): 5.90 x 2.35 x 2.70 m (L x b x h) / 40' HC (binnenmaat): 12.00 x 2.35 x 2.70 m (L x b x h)





QP1208HR3RR



QP1208HR3RR



QP1208HR5RR



800 x 1200 mm

**BESCHIKBARE OPTIES**



ESD



ANTI-SLIP



BEDRUKKING MET LOGO OF TEKST



BRANDVERTRAGEND



RAL-KLEUR



EUROPAL800RR



EUROPAL800RR



QPH1208HP3RR-CDG



QPH1208HP3RR-CDG





900 x 1200 mm

**ONZE PRODUCTEN**

**900 X 1200 MM**

# 900 X 1200 MM HEAVY

L	Light pallet
M	Medium pallet
H	Heavy pallet
↕	Meermalige pallet
→	Enmalige pallet



QP1209HR3R



## SPECIFICATIES

ARTIKEL	ONDERDEK	GEBRUIK	RAND	BOVENDEK	AFMETINGEN			LAADCAPACITEIT			
					LENGTE	BREEDTE	HOOGTE	STATISCH	DYNAMISCH	PALLETSTELLING	GEWICHT
QP1209HB3R	3 onderlatten	eenmalig	-	open	1200	900	156	7500	1500	1000	17,90
QP1209HB3RR	3 onderlatten	eenmalig	✓	open	1200	900	156	7500	1500	1000	17,90
QP1209HR3R	3 onderlatten	meermalig	-	open	1200	900	156	7500	1500	1000	17,90
QP1209HR3RR	3 onderlatten	meermalig	✓	open	1200	900	156	7500	1500	1000	17,90
QP1209HB5R	5 onderlatten	eenmalig	-	open	1200	900	156	7500	1500	1000	18,90
QP1209HB5RR	5 onderlatten	eenmalig	✓	open	1200	900	156	7500	1500	1000	18,90
QP1209HR5R	5 onderlatten	meermalig	-	open	1200	900	156	7500	1500	1000	18,90
QP1209HR5RR	5 onderlatten	meermalig	✓	open	1200	900	156	7500	1500	1000	18,90

## VRACHTLADINGEN

ARTIKEL	STANDAARD TRUCK*		JUMBO TRAILER*		20' HC CONTAINER*		40' HC CONTAINER*	
	STAPEL	TOTAAL	STAPEL	TOTAAL	STAPEL	TOTAAL	STAPEL	TOTAAL
QP1209HB3R	15	450	18	540	17	136	17	340
QP1209HB3RR	15	450	18	540	17	136	17	340
QP1209HR3R	15	450	18	540	17	136	17	340
QP1209HR3RR	15	450	18	540	17	136	17	340
QP1209HB5R	15	450	18	540	17	136	17	340
QP1209HB5RR	15	450	18	540	17	136	17	340
QP1209HR5R	15	450	18	540	17	136	17	340
QP1209HR5RR	15	450	18	540	17	136	17	340

\* Standaard truck: 13.60 x 2.44 - 2.48 x 2.65 m (L x b x h) / Jumbo trailer: 7.60-7.60 x 2.45 x 3.00 m (L x b x h) / 20' HC (binnenmaat): 5.90 x 2.35 x 2.70 m (L x b x h) / 40' HC (binnenmaat): 12.00 x 2.35 x 2.70 m (L x b x h)



QP1209HR3R



QP1209HR3R - Zonder rand



900 x 1200 mm

### BESCHIKBARE OPTIES

- ESD
- BRANDVERTRAGEND

- ANTI-SLIP
- RAL-KLEUR

- BEDRUKKING MET LOGO OF TEKST

"DEZE PALLET STELT EIERPRODUCENTEN IN STAAT HUN EIEREN MET GEMAK EN HOGE SNELHEID TE PALLETISEREN"



QP1209HR5RR



QP1209HR5RR



QP1209HR5RR







# VLEES- VERWERKENDE INDUSTRIE

Vlees is een bederfelijk product. Tijdens alle stappen van het productie- en distributieproces gelden daarom de strenge HACCP-richtlijnen voor voedselveiligheid. Belangrijk is dat pallets naadloos in de hygiënische productie- of verpakkingsprocessen van deze industrie passen. Dat betekent ook dat ze op tijd geleverd moeten worden. Omdat pallets zeker bij grote afstanden niet altijd retour komen, is de prijs zeer belangrijk. De gestandaardiseerde H1 hygiënpallet is een goede keuze, maar er zijn ook andere opties. Q-PALL levert kostenefficiënte, betrouwbare pallets die voldoen aan de strenge hygiënevoorschriften voor de vleesverwerkende industrie.







1000 x 1200 mm

**ONZE PRODUCTEN**

**1000 X 1200 MM**

# 1000 X 1200 MM LIGHT

L	Light pallet
M	Medium pallet
H	Heavy pallet
↕	Meermalige pallet
→	Enmalige pallet



QP1210LB3R



## SPECIFICATIES

ARTIKEL	ONDERDEK	GEBRUIK	RAND	BOVENDEK	AFMETINGEN			LAADCAPACITEIT			GEWICHT
					LENGTE	BREEDTE	HOOGTE	STATISCH	DYNAMISCH	PALLETSTELLING	
QP1210LB9F	9 pootjes nestbaar	eenmalig	-	open	1200	1000	150	2500	1000	0	7,0
QP1210LB9FR	9 pootjes nestbaar	eenmalig	✓	open	1200	1000	150	2500	1000	0	7,0
QP1210LB3R	3 onderlatten	eenmalig	-	open	1200	1000	160	2500	1000	0	8,4
QP1210LB3RR	3 onderlatten	eenmalig	✓	open	1200	1000	160	2500	1000	0	8,4
QP1210LB9F-CD	9 pootjes nestbaar	eenmalig	-	gesloten	1200	1000	150	2500	1000	0	8,2
QP1210LB9FR-CD	9 pootjes nestbaar	eenmalig	✓	gesloten	1200	1000	150	2500	1000	0	8,2
QP1210LB3R-CD	3 onderlatten	eenmalig	-	gesloten	1200	1000	150	2500	1000	0	9,6
QP1210LB3RR-CD	3 onderlatten	eenmalig	✓	gesloten	1200	1000	150	2500	1000	0	9,6

## VRACHTLADINGEN

ARTIKEL	STANDAARD TRUCK*		JUMBO TRAILER*		20' HC CONTAINER*		40' HC CONTAINER*	
	STAPEL	TOTAAL	STAPEL	TOTAAL	STAPEL	TOTAAL	STAPEL	TOTAAL
QP1210LB9F	48	1248	55	1650	48	480	48	1008
QP1210LB9FR	48	1248	55	1650	48	480	48	1008
QP1210LB3R	16	416	17	510	16	160	16	336
QP1210LB3RR	16	416	17	510	16	160	16	336
QP1210LB9F-CD	48	1248	55	1650	48	480	48	1008
QP1210LB9FR-CD	48	1248	55	1650	48	480	48	1008
QP1210LB3R-CD	16	416	17	510	16	160	16	336
QP1210LB3RR-CD	16	416	17	510	16	160	16	336

\* Standaard truck: 13.60 x 2.44 - 2.48 x 2.65 m (L x b x h) / Jumbo trailer: 7.60-7.60 x 2.45 x 3.00 m (L x b x h) / 20' HC (binnenmaat): 5.90 x 2.35 x 2.70 m (L x b x h) / 40' HC (binnenmaat): 12.00 x 2.35 x 2.70 m (L x b x h)



**BESCHIKBARE OPTIES**



BRANDVERTRAGEND



RAL-KLEUR



1000 x 1200 mm

# 1000 X 1200 MM MEDIUM

L	Light pallet
M	Medium pallet
H	Heavy pallet
↕	Meermalige pallet
→	Eenmalige pallet



1.QP1210MR3RR



## SPECIFICATIES

ARTIKEL	ONDERDEK	GEBRUIK	RAND	BOVENDEK	AFMETINGEN			LAADCAPACITEIT			
					LENGTE	BREEDTE	HOOGTE	STATISCH	DYNAMISCH	PALLETSTELLING	GEWICHT
1QP1210MB3R	3 onderlatten	eenmalig	-	open	1200	1000	165	6000	1250	350	13,97
1QP1210MB3RR	3 onderlatten	eenmalig	✓	open	1200	1000	165	6000	1250	350	13,97
1QP1210MB6R	6 onderlatten	eenmalig	-	open	1200	1000	165	6000	1250	800	15,95
1QP1210MB6RR	6 onderlatten	eenmalig	✓	open	1200	1000	165	6000	1250	800	15,95
1QP1210MR3R	3 onderlatten	meermalig	-	open	1200	1000	165	6000	1250	350	14,95
1QP1210MR3RR	3 onderlatten	meermalig	✓	open	1200	1000	165	6000	1250	350	14,95
1QP1210MR6R	6 onderlatten	meermalig	-	open	1200	1000	165	6000	1250	800	15,90
1QP1210MR6RR	6 onderlatten	meermalig	✓	open	1200	1000	165	6000	1250	800	15,90

## VRACHTLADINGEN

ARTIKEL	STANDAARD TRUCK*		JUMBO TRAILER*		20' HC CONTAINER*		40' HC CONTAINER*	
	STAPEL	TOTAAL	STAPEL	TOTAAL	STAPEL	TOTAAL	STAPEL	TOTAAL
1QP1210MB3R	15	390	17	510	16	160	16	336
1QP1210MB3RR	15	390	17	510	16	160	16	336
1QP1210MB6R	15	390	17	510	16	160	16	336
1QP1210MB6RR	15	390	17	510	16	160	16	336
1QP1210MR3R	15	390	17	510	16	160	16	336
1QP1210MR3RR	15	390	17	510	16	160	16	336
1QP1210MR6R	15	390	17	510	16	160	16	336
1QP1210MR6RR	15	390	17	510	16	160	16	336

\* Standaard truck: 13.60 x 2.44 - 2.48 x 2.65 m (L x b x h) / Jumbo trailer: 7.60-7.60 x 2.45 x 3.00 m (L x b x h) / 20' HC (binnenmaat): 5.90 x 2.35 x 2.70 m (L x b x h) / 40' HC (binnenmaat): 12.00 x 2.35 x 2.70 m (L x b x h)



1.QP1210MR6RR



### BESCHIKBARE OPTIES



ESD



ANTI-SLIP



BEDRUKKING MET LOGO OF TEKST



BRANDVERTRAGEND



RAL-KLEUR



1.QP1210MR3RR



1.QP1210MR6RR



1000 x 1200 mm

# 1000 X 1200 MM MEDIUM

L	Light pallet
M	Medium pallet
H	Heavy pallet
↕	Meermalige pallet
→	Enmalige pallet

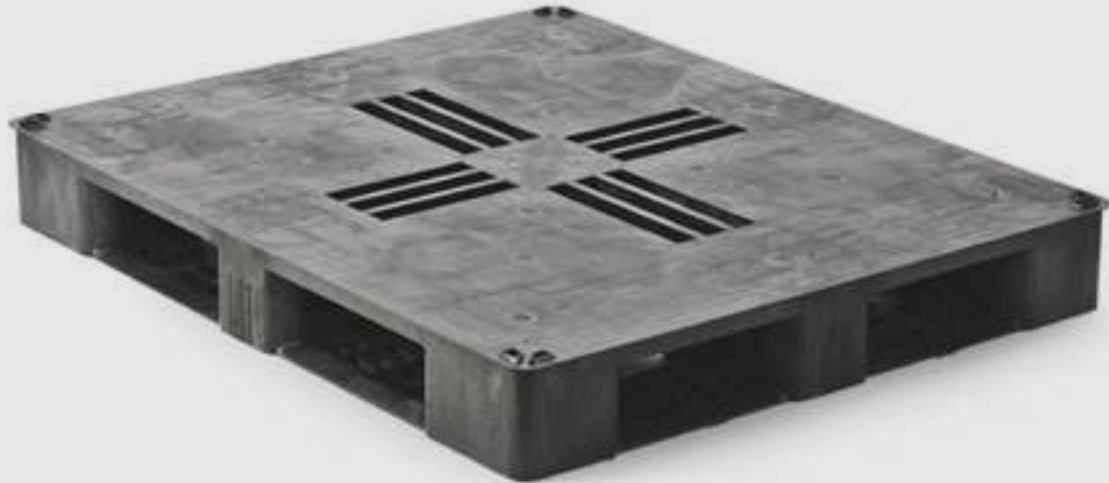

QP1210MR6R-ASCD



## SPECIFICATIES

ARTIKEL	ONDERDEK	GEBRUIK	RAND	BOVENDEK	AFMETINGEN			LAADCAPACITEIT			GEWICHT
					LENGTE	BREEDTE	HOOGTE	STATISCH	DYNAMISCH	PALLETSTELLING	
2QP1210MB3R	3 onderlatten	eenmalig	-	open	1200	1000	150	6000	1250	350	15,54
2QP1210MB3RR	3 onderlatten	eenmalig	✓	open	1200	1000	150	6000	1250	350	15,54
2QP1210MB3R-CD	3 onderlatten	eenmalig	-	gesloten	1200	1000	150	6000	1250	1000	17,75
2QP1210MB3RR-CD	3 onderlatten	eenmalig	✓	gesloten	1200	1000	150	6000	1250	1000	17,75
2QP1210MB6R	6 onderlatten	eenmalig	-	open	1200	1000	150	6000	1250	800	16,10
2QP1210MB6RR	6 onderlatten	eenmalig	✓	open	1200	1000	150	6000	1250	800	16,10
2QP1210MB6R-CD	6 onderlatten	eenmalig	-	gesloten	1200	1000	150	6000	1250	1000	16,90
2QP1210MB6RR-CD	6 onderlatten	eenmalig	✓	gesloten	1200	1000	150	6000	1250	1000	16,90

ARTIKEL	ONDERDEK	GEBRUIK	RAND	BOVENDEK	AFMETINGEN			LAADCAPACITEIT			GEWICHT
					LENGTE	BREEDTE	HOOGTE	STATISCH	DYNAMISCH	PALLETSTELLING	
2QP1210MR3R	3 onderlatten	meermalig	-	open	1200	1000	150	6000	1250	350	15,33
2QP1210MR3RR	3 onderlatten	meermalig	✓	open	1200	1000	150	6000	1250	350	15,33
2QP1210MR3R-CD	3 onderlatten	meermalig	-	gesloten	1200	1000	150	6000	1250	1000	17,75
2QP1210MR3RR-CD	3 onderlatten	meermalig	✓	gesloten	1200	1000	150	6000	1250	1000	17,75
2QP1210MR6R	6 onderlatten	meermalig	-	open	1200	1000	150	6000	1250	800	16,10
2QP1210MR6RR	6 onderlatten	meermalig	✓	open	1200	1000	150	6000	1250	800	16,10
2QP1210MR6R-CD	6 onderlatten	meermalig	-	gesloten	1200	1000	150	6000	1250	1000	17,54
2QP1210MR6RR-CD	6 onderlatten	meermalig	✓	gesloten	1200	1000	150	6000	1250	1000	17,54



2.QP1210MR3RR-CD



2.QP1210MR3RR-CD



2.QP1210MR6RR-CD



## BESCHIKBARE OPTIES



ESD



ANTI-SLIP



BEDRUKKING MET LOGO OF TEKST



BRANDVERTRAGEND



RAL-KLEUR



2.QP1210MR3RR



2.QP1210MR6RR



## VRACHTLADINGEN

ARTIKEL	STANDAARD TRUCK*		JUMBO TRAILER*		20' HC CONTAINER*		40' HC CONTAINER*	
	STAPEL	TOTAAL	STAPEL	TOTAAL	STAPEL	TOTAAL	STAPEL	TOTAAL
2QP1210Mx3R	17	442	19	570	17	170	17	357
2QP1210Mx3RR	17	442	19	570	17	170	17	357
2QP1210Mx3R-CD	17	442	19	570	17	170	17	357
2QP1210Mx3RR-CD	17	442	19	570	17	170	17	357
2QP1210Mx6R	17	442	19	570	17	170	17	357
2QP1210Mx6RR	17	442	19	570	17	170	17	357
2QP1210Mx6R-CD	17	442	19	570	17	170	17	357
2QP1210Mx6RR-CD	17	442	19	570	17	170	17	357

\* Standaard truck: 13.60 x 2.44 - 2.48 x 2.65 m (L x b x h) / Jumbo trailer: 7.60-7.60 x 2.45 x 3.00 m (L x b x h) / 20'HC (binnenmaat): 5.90 x 2.35 x 2.70 m (L x b x h) / 40' HC (binnenmaat): 12.00 x 2.35 x 2.70 m (L x b x h)

1000 x 1200 mm

# 1000 X 1200 MM HEAVY

L	Light pallet
M	Medium pallet
H	Heavy pallet
↕	Meermalige pallet
→	Eenmalige pallet



QP1210HR3RR



## SPECIFICATIES

ARTIKEL	ONDERDEK	GEBRUIK	RAND	BOVENDEK	AFMETINGEN			LAADCAPACITEIT			GEWICHT
					LENGTE	BREEDTE	HOOGTE	STATISCH	DYNAMISCH	PALLETSTELLING	
QP1210HB3R	3 onderlatten	eenmalig	-	open	1200	1000	160	7500	1500	1250	19,73
QP1210HB3RR	3 onderlatten	eenmalig	✓	open	1200	1000	160	7500	1500	1250	19,73
QP1210HB5R	5 onderlatten	eenmalig	-	open	1200	1000	160	7500	1500	1375	20,95
QP1210HB5RR	5 onderlatten	eenmalig	✓	open	1200	1000	160	7500	1500	1375	20,95
QP1210HR3R	3 onderlatten	meermalig	-	open	1200	1000	160	7500	1500	1250	19,36
QP1210HR3RR	3 onderlatten	meermalig	✓	open	1200	1000	160	7500	1500	1250	19,36
QP1210HR5R	5 onderlatten	meermalig	-	open	1200	1000	160	7500	1500	1375	20,93
QP1210HR5RR	5 onderlatten	meermalig	✓	open	1200	1000	160	7500	1500	1375	20,93

## VRACHTLADINGEN

ARTIKEL	STANDAARD TRUCK*		JUMBO TRAILER*		20' HC CONTAINER*		40' HC CONTAINER*	
	STAPEL	TOTAAL	STAPEL	TOTAAL	STAPEL	TOTAAL	STAPEL	TOTAAL
QP1210HB3R	15	390	17	510	16	160	16	336
QP1210HB3RR	15	390	17	510	16	160	16	336
QP1210HB5R	15	390	17	510	16	160	16	336
QP1210HB5RR	15	390	17	510	16	160	16	336
QP1210HR3R	15	390	17	510	16	160	16	336
QP1210HR3RR	15	390	17	510	16	160	16	336
QP1210HR5R	15	390	17	510	16	160	16	336
QP1210HR5RR	15	390	17	510	16	160	16	336

\* Standaard truck: 13.60 x 2.44 - 2.48 x 2.65 m (L x b x h) / Jumbo trailer: 7.60-7.60 x 2.45 x 3.00 m (L x b x h) / 20' HC (binnenmaat): 5.90 x 2.35 x 2.70 m (L x b x h) / 40' HC (binnenmaat): 12.00 x 2.35 x 2.70 m (L x b x h)





QP1210HR5RR



QP1210HR3RR



QP1210HR5RR



**BESCHIKBARE OPTIES**



ESD



ANTI-SLIP



BEDRUKKING MET LOGO OF TEKST



BRANDVERTRAGEND



RAL-KLEUR

1000 x 1200 mm



QP1210HR5RR



Randen van 22 mm

# 1000 X 1200 MM HEAVY

L	Light pallet
M	Medium pallet
H	Heavy pallet
↕	Meermalige pallet
→	Eenmalige pallet



QP1210HR3RR-CD



## SPECIFICATIES

ARTIKEL	ONDERDEK	GEBRUIK	RAND	BOVENDEK	AFMETINGEN			LAADCAPACITEIT			GEWICHT
					LENGTE	BREEDTE	HOOGTE	STATISCH	DYNAMISCH	PALLETSTELLING	
2QP1210HB3R	3 onderlatten	eenmalig	-	open	1200	1000	158	7500	1500	1250	20,48
2QP1210HB3RR	3 onderlatten	eenmalig	✓	open	1200	1000	158	7500	1500	1250	20,48
2QP1210HB3R-CD	3 onderlatten	eenmalig	-	gesloten	1200	1000	158	7500	1500	1375	22,05
2QP1210HB3RR-CD	3 onderlatten	eenmalig	✓	gesloten	1200	1000	158	7500	1500	1375	22,05
2QP1210HR3R	3 onderlatten	meermalig	-	open	1200	1000	158	7500	1500	1250	20,45
2QP1210HR3RR	3 onderlatten	meermalig	✓	open	1200	1000	158	7500	1500	1250	20,45
2QP1210HR3R-CD	3 onderlatten	meermalig	-	gesloten	1200	1000	158	7500	1500	1375	22,05
2QP1210HR3RR-CD	3 onderlatten	meermalig	✓	gesloten	1200	1000	158	7500	1500	1375	22,05

## VRACHTLADINGEN

ARTIKEL	STANDAARD TRUCK*		JUMBO TRAILER*		20' HC CONTAINER*		40' HC CONTAINER*	
	STAPEL	TOTAAL	STAPEL	TOTAAL	STAPEL	TOTAAL	STAPEL	TOTAAL
2QP1210HB3R	16	416	18	540	16	160	16	336
2QP1210HB3RR	16	416	18	540	16	160	16	336
QP1210HB3R-CD	16	416	18	540	16	160	16	336
QP1210HB3RR-CD	16	416	18	540	16	160	16	336
2QP1210HR3R	16	416	18	540	16	160	16	336
2QP1210HR3RR	16	416	18	540	16	160	16	336
QP1210HR3R-CD	16	416	18	540	16	160	16	336
QP1210HR3RR-CD	16	416	18	540	16	160	16	336

\* Standaard truck: 13.60 x 2.44 - 2.48 x 2.65 m (L x b x h) / Jumbo trailer: 7.60-7.60 x 2.45 x 3.00 m (L x b x h) / 20' HC (binnenmaat): 5.90 x 2.35 x 2.70 m (L x b x h) / 40' HC (binnenmaat): 12.00 x 2.35 x 2.70 m (L x b x h)



2.QP1210HR3RR



### BESCHIKBARE OPTIES



ESD



ANTI-SLIP



BEDRUKKING MET LOGO OF TEKST



BRANDVERTRAGEND



RAL-KLEUR

1000 x 1200 mm



QP1210HR3RR-CD



# 1000 X 1200 MM HEAVY

L	Light pallet
M	Medium pallet
H	Heavy pallet
↕	Meermalige pallet
→	Eenmalige pallet

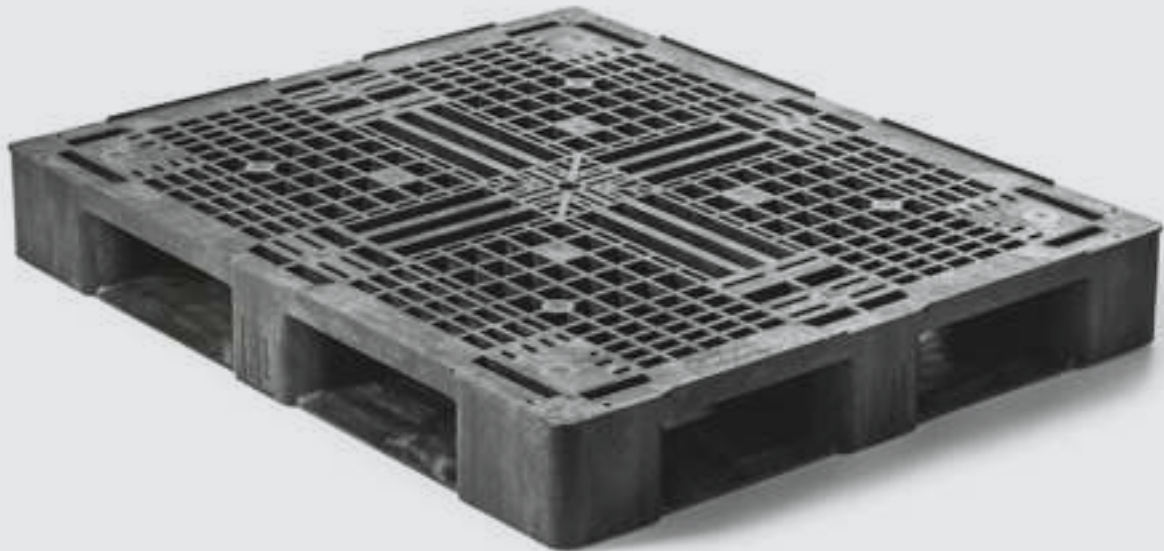

QP1210HR6RR



## SPECIFICATIES

ARTIKEL	ONDERDEK	GEBRUIK	RAND	BOVENDEK	AFMETINGEN			LAADCAPACITEIT			GEWICHT
					LENGTE	BREEDTE	HOOGTE	STATISCH	DYNAMISCH	PALLETSTELLING	
QP1210HB6R	6 onderlatten	eenmalig	-	open	1200	1000	158	7500	1500	1250	21,92
QP1210HB6RR	6 onderlatten	eenmalig	✓	open	1200	1000	158	7500	1500	1250	21,92
QP1210HB6R-CD	6 onderlatten	eenmalig	-	gesloten	1200	1000	158	7500	1500	1375	22,65
QP1210HB6RR-CD	6 onderlatten	eenmalig	✓	gesloten	1200	1000	158	7500	1500	1375	22,65
QP1210HR6R	6 onderlatten	meermalig	-	open	1200	1000	158	7500	1500	1250	21,00
QP1210HR6RR	6 onderlatten	meermalig	✓	open	1200	1000	158	7500	1500	1250	21,00
QP1210HR6R-CD	6 onderlatten	meermalig	-	gesloten	1200	1000	158	7500	1500	1375	22,60
QP1210HR6RR-CD	6 onderlatten	meermalig	✓	gesloten	1200	1000	158	7500	1500	1375	22,60

## VRACHTLADINGEN

ARTIKEL	STANDAARD TRUCK*		JUMBO TRAILER*		20' HC CONTAINER*		40' HC CONTAINER*	
	STAPEL	TOTAAL	STAPEL	TOTAAL	STAPEL	TOTAAL	STAPEL	TOTAAL
QP1210HB6R	16	416	18	540	16	160	16	336
QP1210HB6RR	16	416	18	540	16	160	16	336
QP1210HB6R-CD	16	416	18	540	16	160	16	336
QP1210HB6RR-CD	16	416	18	540	16	160	16	336
QP1210HR6R	16	416	18	540	16	160	16	336
QP1210HR6RR	16	416	18	540	16	160	16	336
QP1210HR6R-CD	16	416	18	540	16	160	16	336
QP1210HR6RR-CD	16	416	18	540	16	160	16	336

\* Standaard truck: 13.60 x 2.44 - 2.48 x 2.65 m (L x b x h) / Jumbo trailer: 7.60-7.60 x 2.45 x 3.00 m (L x b x h) / 20' HC (binnenmaat): 5.90 x 2.35 x 2.70 m (L x b x h) / 40' HC (binnenmaat): 12.00 x 2.35 x 2.70 m (L x b x h)



QP1210HR6R-ASCD



**BESCHIKBARE OPTIES**



ESD



ANTI-SLIP



BEDRUKKING MET LOGO OF TEKST



BRANDVERTRAGEND



RAL-KLEUR

1000 x 1200 mm



QP1210HR6RR



QP1210HR6R-ASCD



# 1000 X 1200 MM HEAVY

L	Light pallet
M	Medium pallet
H	Heavy pallet
↕	Meermalige pallet
→	Enmalige pallet



RECYPAL1210RR



## SPECIFICATIES

ARTIKEL	ONDERDEK	GEBRUIK	RAND	BOVENDEK	AFMETINGEN			LAADCAPACITEIT			GEWICHT
					LENGTE	BREEDTE	HOOGTE	STATISCH	DYNAMISCH	PALLETSTELLING	
Recypal1210R	3 onderlatten	meermalig	-	gesloten	1200	1000	150	5000	1500	900	28,0
Recypal1210RR	3 onderlatten	meermalig	✓	gesloten	1200	1000	150	5000	1500	900	28,0
QPH1210HP3RR-CDG	3 onderlatten	meermalig	✓	gesloten	1200	1000	160	7500	1500	1250	21,5
QPH1210HP3RR-CDB	3 onderlatten	meermalig	✓	gesloten	1200	1000	160	7500	1500	1250	21,5
QPH1210HP3RR-CDG*	3 onderlatten	meermalig	✓	gesloten	1200	1000	160	7500	1500	2000	21,5
QPH1210HP3RR-CDB*	3 onderlatten	meermalig	✓	gesloten	1200	1000	160	7500	1500	2000	21,5
QPH1210HP5RR-CDB	5 onderlatten	meermalig	✓	gesloten	1200	1000	160	7500	1500	1250	22,5
QPH1210HP5RR-CDG	5 onderlatten	meermalig	✓	gesloten	1200	1000	160	7500	1250	1250	22,5
QPH1210HP5RR-CDB*	5 onderlatten	meermalig	✓	gesloten	1200	1000	160	7500	1500	2000	22,5
QPH1210HP5RR-CDG*	5 onderlatten	meermalig	✓	gesloten	1200	1000	160	7500	1250	2000	22,5

## VRACHTLADINGEN

ARTIKEL	STANDAARD TRUCK*		JUMBO TRAILER*		20' HC CONTAINER*		40' HC CONTAINER*	
	STAPEL	TOTAAL	STAPEL	TOTAAL	STAPEL	TOTAAL	STAPEL	TOTAAL
Recypal1210R	23	506	23	552	17	170	17	357
Recypal1210RR	23	506	23	552	17	170	17	357
QPH1210HP3RR-CDG	15	390	17	510	16	160	16	336
QPH1210HP3RR-CDB	15	390	17	510	16	160	16	336
QPH1210HP3RR-CDG*	15	390	17	510	16	160	16	336
QPH1210HP3RR-CDB*	15	390	17	510	16	160	16	336
QPH1210HP5RR-CDB	15	390	17	510	16	160	16	336
QPH1210HP5RR-CDG	15	390	17	510	16	160	16	336
QPH1210HP5RR-CDB*	15	390	17	510	16	160	16	336
QPH1210HP5RR-CDG*	15	390	17	510	16	160	16	336

\* Standaard truck: 13.60 x 2.44 - 2.48 x 2.65 m (L x b x h) / Jumbo trailer: 7.60-7.60 x 2.45 x 3.00 m (L x b x h) / 20' HC (binnenmaat): 5.90 x 2.35 x 2.70 m (L x b x h) / 40' HC (binnenmaat): 12.00 x 2.35 x 2.70 m (L x b x h)



RECPAL1210RR



**BESCHIKBARE OPTIES**



ESD



ANTI-SLIP



BEDRUKKING MET LOGO OF TEKST



BRANDVERTRAGEND



RAL-KLEUR

1000 x 1200 mm



QPH1210HP3RR-CDG



QPH1210HP5RR-CDB







# AUTOMOTIVE INDUSTRIE

Kunststof pallets worden steeds populairder in de auto-industrie. Nu houten pallets uit een open palletpool steeds meer tekortschieten, kiezen veel bedrijven ervoor om eigen plastic pallets aan te schaffen. Deze moeten ingepast kunnen worden in de voor de automotive industrie kenmerkende transportbandsystemen, compleet met elektronische traceerbaarheid. Dat is bij onze pallets het geval. Ze hebben daarnaast uitstekende antistatische eigenschappen, waardoor zelfs de meest delicate technische onderdelen per pallet vervoerd kunnen worden. Ook in de automotive branche verloopt met Q-PALL pallets alles op rolletjes.





1020 x 1220 mm

**ONZE PRODUCTEN**

**1020 X 1220 MM**

# 1020 X 1220 MM MEDIUM

## 40' X 48' AMERIKAANSE STANDAARD

L	Light pallet
M	Medium pallet
H	Heavy pallet
↕	Meermalige pallet
→	Eenmalige pallet

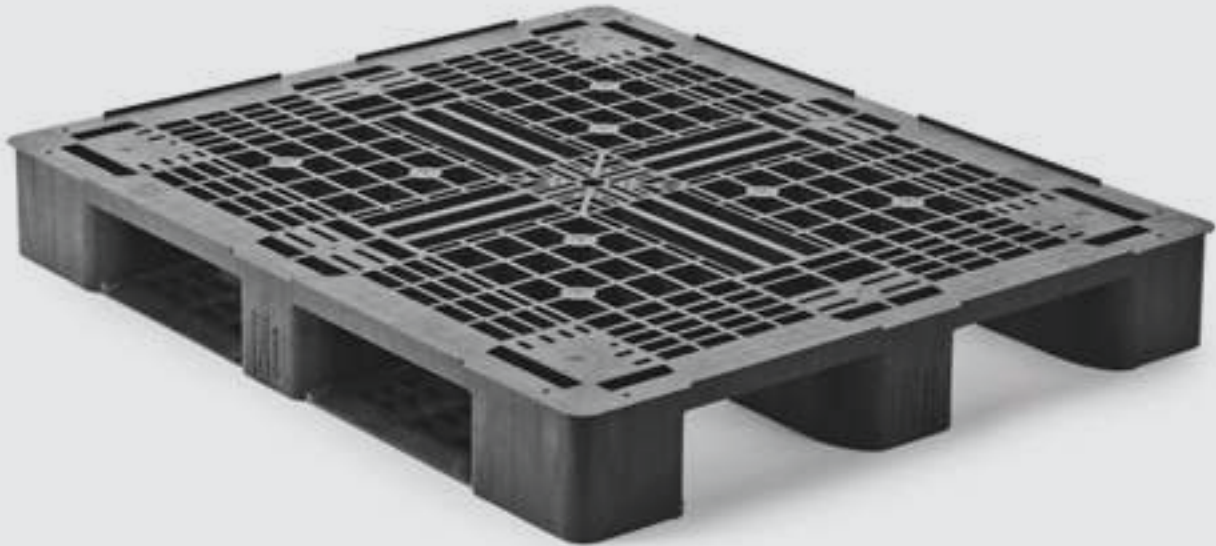

QP4048MR3RR



### SPECIFICATIES

ARTIKEL	ONDERDEK	GEBRUIK	RAND	BOVENDEK	AFMETINGEN			LAADCAPACITEIT			GEWICHT
					LENGTE	BREEDTE	HOOGTE	STATISCH	DYNAMISCH	PALLETSTELLING	
QP4048MB3R	3 onderlatten	eenmalig	-	open	1220	1020	150	6000	1250	350	15,54
QP4048MB3RR	3 onderlatten	eenmalig	✓	open	1220	1020	150	6000	1250	350	15,54
QP4048MR3R	3 onderlatten	meermalig	-	open	1220	1020	150	6000	1250	350	15,09
QP4048MR3RR	3 onderlatten	meermalig	✓	open	1220	1020	150	6000	1250	350	15,09
QP4048MB3R-CD	3 onderlatten	eenmalig	-	gesloten	1220	1020	150	6000	1250	1000	17,75
QP4048MB3RR-CD	3 onderlatten	eenmalig	✓	gesloten	1220	1020	150	6000	1250	1000	17,75
QP4048MR3R-CD	3 onderlatten	meermalig	-	gesloten	1220	1020	150	6000	1250	1000	16,25
QP4048MR3RR-CD	3 onderlatten	meermalig	✓	gesloten	1220	1020	150	6000	1250	1000	16,25

### VRACHTLADINGEN

ARTIKEL	STANDAARD TRUCK*		JUMBO TRAILER*		20' HC CONTAINER*		40' HC CONTAINER*	
	STAPEL	TOTAAL	STAPEL	TOTAAL	STAPEL	TOTAAL	STAPEL	TOTAAL
QP4048MB3R	17	442	19	570	17	170	17	357
QP4048MB3RR	17	442	19	570	17	170	17	357
QP4048MR3R	17	442	19	570	17	170	17	357
QP4048MR3RR	17	442	19	570	17	170	17	357
QP4048MB3R-CD	17	442	19	570	17	170	17	357
QP4048MB3RR-CD	17	442	19	570	17	170	17	357
QP4048MR3R-CD	17	442	19	570	17	170	17	357
QP4048MR3RR-CD	17	442	19	570	17	170	17	357

\* Standaard truck: 13.60 x 2.44 - 2.48 x 2.65 m (L x b x h) / Jumbo trailer: 7.60-7.60 x 2.45 x 3.00 m (L x b x h) / 20' HC (binnenmaat): 5.90 x 2.35 x 2.70 m (L x b x h) / 40' HC (binnenmaat): 12.00 x 2.35 x 2.70 m (L x b x h)



QP4048MR3RR

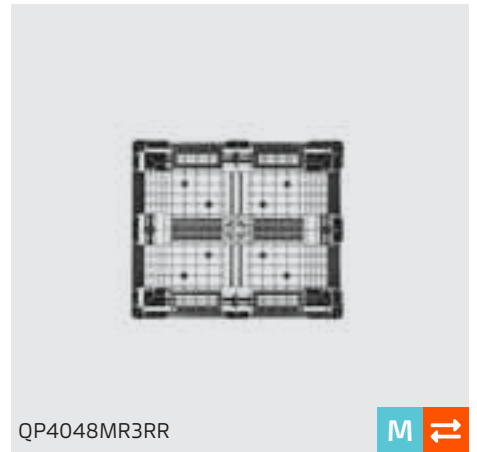

QP4048MR3RR



QP4048MR3RR



**BESCHIKBARE OPTIES**



ESD



ANTI-SLIP



BEDRUKKING MET LOGO OF TEKST



BRANDVERTRAGEND



RAL-KLEUR



QP4048MR3RR-CD



"OOK BEKEND ALS  
40" X 48" PALLET.  
DE MEEST GEBRUIKTE  
PALLETAFMETING  
IN DE U.S.A."



QP4048MR3RR-CD



1020 x 1220 mm

# 1020 X 1220 MM MEDIUM

## 40' X 48' AMERIKAANSE STANDAARD

L	Light pallet
M	Medium pallet
H	Heavy pallet
↕	Meermalige pallet
→	Eenmalige pallet

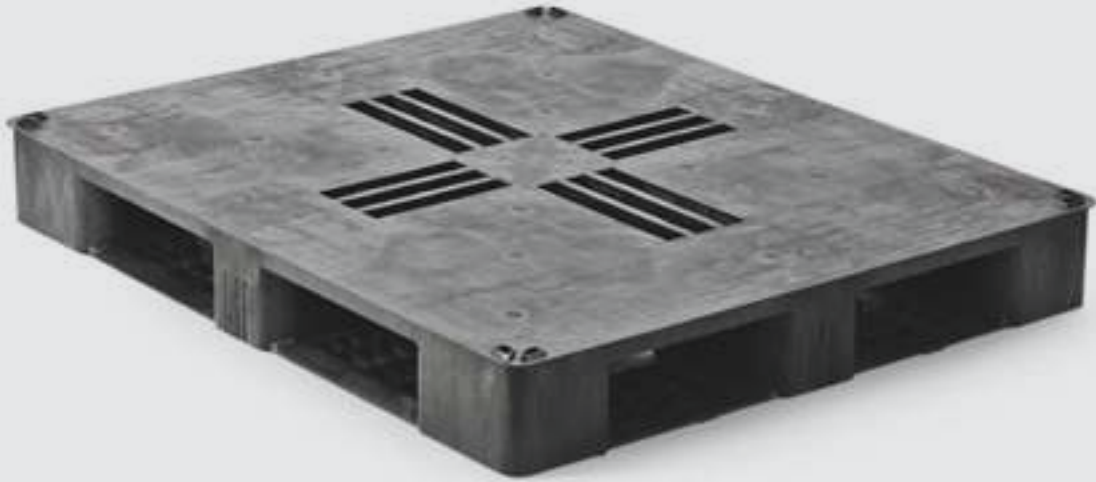

QP4048MB6R-CD



### SPECIFICATIES

ARTIKEL	ONDERDEK	GEBRUIK	RAND	BOVENDEK	AFMETINGEN			LAADCAPACITEIT			
					LENGTE	BREEDTE	HOOGTE	STATISCH	DYNAMISCH	PALLETSTELLING	GEWICHT
QP4048MB6R	6 onderlatten	eenmalig	-	open	1220	1020	150	6000	1250	800	16,10
QP4048MB6RR	6 onderlatten	eenmalig	✓	open	1220	1020	150	6000	1250	800	16,10
QP4048MR6R	6 onderlatten	meermalig	-	open	1220	1020	150	6000	1250	800	16,05
QP4048MR6RR	6 onderlatten	meermalig	✓	open	1220	1020	150	6000	1250	800	16,05
QP4048MB6R-CD	6 onderlatten	eenmalig	-	gesloten	1220	1020	150	6000	1250	1000	16,90
QP4048MB6RR-CD	6 onderlatten	eenmalig	✓	gesloten	1220	1020	150	6000	1250	1000	16,90
QP4048MR6R-CD	6 onderlatten	meermalig	-	gesloten	1220	1020	150	6000	1250	1000	17,21
QP4048MR6RR-CD	6 onderlatten	meermalig	✓	gesloten	1220	1020	150	6000	1250	1000	17,21

### VRACHTLADINGEN

ARTIKEL	STANDAARD TRUCK*		JUMBO TRAILER*		20' HC CONTAINER*		40' HC CONTAINER*	
	STAPEL	TOTAAL	STAPEL	TOTAAL	STAPEL	TOTAAL	STAPEL	TOTAAL
QP4048MB6R	17	442	19	570	17	170	17	357
QP4048MB6RR	17	442	19	570	17	170	17	357
QP4048MR6R	17	442	19	570	17	170	17	357
QP4048MR6RR	17	442	19	570	17	170	17	357
QP4048MB6R-CD	17	442	19	570	17	170	17	357
QP4048MB6RR-CD	17	442	19	570	17	170	17	357
QP4048MR6R-CD	17	442	19	570	17	170	17	357
QP4048MR6RR-CD	17	442	19	570	17	170	17	357

\* Standaard truck: 13.60 x 2.44 - 2.48 x 2.65 m (L x b x h) / Jumbo trailer: 7.60-7.60 x 2.45 x 3.00 m (L x b x h) / 20' HC (binnenmaat): 5.90 x 2.35 x 2.70 m (L x b x h) / 40' HC (binnenmaat): 12.00 x 2.35 x 2.70 m (L x b x h)



QP4048MB6R-CD



QP4048MB6R-CD



**BESCHIKBARE OPTIES**



ESD



ANTI-SLIP



BEDRUKKING MET LOGO OF TEKST



BRANDVERTRAGEND



RAL-KLEUR



QP4048MB6R

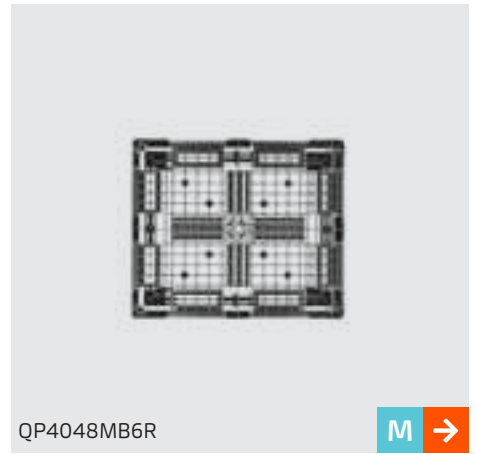

QP4048MB6R



QP4048MB6R



1020 x 1220 mm





**ONZE PRODUCTEN**

**1100 X 1100 MM**



1100 x 1100 mm

# 1100 X 1100 MM LIGHT

L	Light pallet
M	Medium pallet
H	Heavy pallet
↕	Meermalige pallet
→	Eenmalige pallet



QP1111LR3RR



## SPECIFICATIES

ARTIKEL	ONDERDEK	GEBRUIK	RAND	BOVENDEK	AFMETINGEN			LAADCAPACITEIT			GEWICHT
					LENGTE	BREEDTE	HOOGTE	STATISCH	DYNAMISCH	PALLETSTELLING	
QP1111LR9F	9 pootjes nestbaar	eenmalig	-	open	1100	1100	150	2500	1000	0	6,62
QP1111LR9FR	9 pootjes nestbaar	eenmalig	✓	open	1100	1100	150	2500	1000	0	6,62
QP1111LR3R	3 onderlatten	eenmalig	-	open	1100	1100	150	2500	1000	0	8,45
QP1111LR3RR	3 onderlatten	eenmalig	✓	open	1100	1100	150	2500	1000	0	8,45

## VRACHTLADINGEN

ARTIKEL	STANDAARD TRUCK*		JUMBO TRAILER*		20' HC CONTAINER*		40' HC CONTAINER*	
	STAPEL	TOTAAL	STAPEL	TOTAAL	STAPEL	TOTAAL	STAPEL	TOTAAL
QP1111LR9F	55	1320	60	1560	55	550	55	1100
QP1111LR9FR	55	1320	60	1560	55	550	55	1100
QP1111LR3R	16	384	17	442	16	160	16	320
QP1111LR3RR	16	384	17	442	16	160	16	320

\* Standaard truck: 13.60 x 2.44 - 2.48 x 2.65 m (L x b x h) / Jumbo trailer: 7.60-7.60 x 2.45 x 3.00 m (L x b x h) / 20' HC (binnenmaat): 5.90 x 2.35 x 2.70 m (L x b x h) / 40' HC (binnenmaat): 12.00 x 2.35 x 2.70 m (L x b x h)



QP1111LR9FR



**BESCHIKBARE OPTIES**



ESD



ANTI-SLIP



BEDRUKKING MET LOGO OF TEKST



BRANDVERTRAGEND



RAL-KLEUR

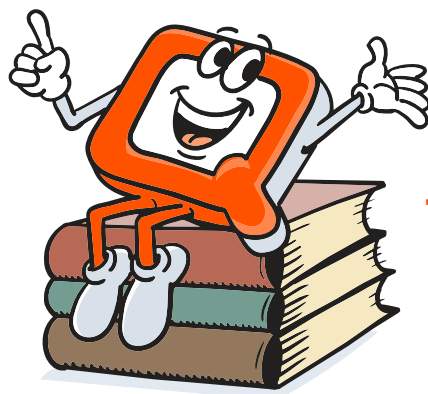

**"DE MEEST POPULAIRE  
PALLET VOOR EXPORT  
NAAR AZIË"**



1100 x 1100 mm



QP1111LR9FR



QP1111LR3RR



# 1100 X 1100 MM MEDIUM

L	Light pallet
M	Medium pallet
H	Heavy pallet
↕	Meermalige pallet
→	Eenmalige pallet



QP1111MR3R-AS



## SPECIFICATIES

ARTIKEL	ONDERDEK	GEBRUIK	RAND	BOVENDEK	AFMETINGEN			LAADCAPACITEIT			GEWICHT
					LENGTE	BREEDTE	HOOGTE	STATISCH	DYNAMISCH	PALLESTELLING	
QP1111MB3R-AS	3 onderlatten	eenmalig	Anti-slip   Stapelnok	open	1100	1100	150	5000	1250	250	12,00
QP1111MR3R-AS	3 onderlatten	meermalig	Anti-slip   Stapelnok	open	1100	1100	150	5000	1250	250	11,79
QP1111MB6R-AS	6 onderlatten	eenmalig	Anti-slip   Stapelnok	open	1100	1100	150	5000	1250	250	13,54
QP1111MR6R-AS	6 onderlatten	meermalig	Anti-slip   Stapelnok	open	1100	1100	150	5000	1250	250	12,94

## VRACHTLADINGEN

ARTIKEL	STANDAARD TRUCK*		JUMBO TRAILER*		20' HC CONTAINER*		40' HC CONTAINER*	
	STAPEL	TOTAAL	STAPEL	TOTAAL	STAPEL	TOTAAL	STAPEL	TOTAAL
QP1111MB3R-AS	17	408	19	494	17	170	17	357
QP1111MR3R-AS	17	408	19	494	17	170	17	357
QP1111MB6R-AS	17	408	19	494	17	170	17	357
QP1111MR6R-AS	17	408	19	494	17	170	17	357

\* Standaard truck: 13.60 x 2.44 - 2.48 x 2.65 m (L x b x h) / Jumbo trailer: 7.60-7.60 x 2.45 x 3.00 m (L x b x h) / 20' HC (binnenmaat): 5.90 x 2.35 x 2.70 m (L x b x h) / 40' HC (binnenmaat): 12.00 x 2.35 x 2.70 m (L x b x h)



QP1111MR3R-AS



QP1111MR3R-AS

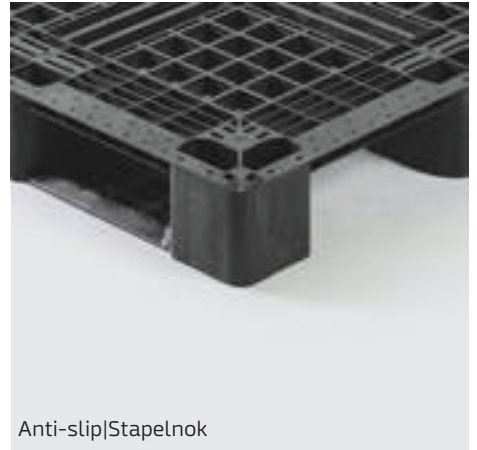

Anti-slip|Stapelnok

**BESCHIKBARE OPTIES**



ESD



ANTI-SLIP



BEDRUKKING MET LOGO OF TEKST



BRANDVERTRAGEND



RAL-KLEUR



QP1111MR6R-AS

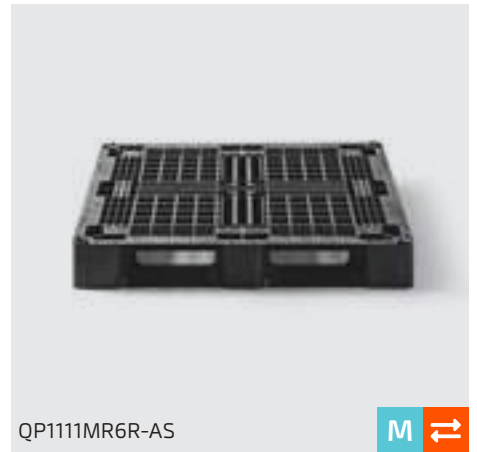

QP1111MR6R-AS



QP1111MR6R-AS



1100 x 1100 mm



Demag



Demag





**ONZE PRODUCTEN**

**1100 X 1300 MM**

1100 x 1300 mm

# 1100 X 1300 MM MEDIUM

L	Light pallet
M	Medium pallet
H	Heavy pallet
↕	Meermalige pallet
→	Eenmalige pallet

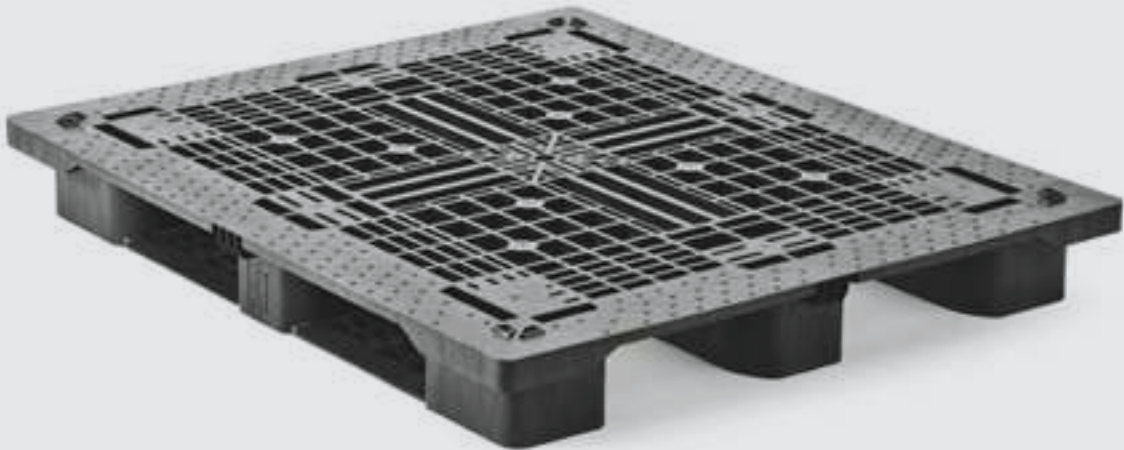

QP1311MR3R-AS



## SPECIFICATIES

ARTIKEL	ONDERDEK	GEBRUIK	RAND	BOVENDEK	AFMETINGEN			LAADCAPACITEIT			
					LENGTE	BREEDTE	HOOGTE	STATISCH	DYNAMISCH	PALLETSTELLING	GEWICHT
QP1311MB3R-AS	3 onderlatten	eenmalig	Anti-slip   Stapelnok	open	1300	1100	150	6000	1250	350	16,70
QP1311MR3R-AS	3 onderlatten	meermalig	Anti-slip   Stapelnok	open	1300	1100	150	6000	1250	350	16,70
QP1311MB6R-AS	6 onderlatten	eenmalig	Anti-slip   Stapelnok	open	1300	1100	150	6000	1250	800	17,51
QP1311MR6R-AS	6 onderlatten	meermalig	Anti-slip   Stapelnok	open	1300	1100	150	6000	1250	800	17,51
QP1311MB3R-ASCD	3 onderlatten	eenmalig	Anti-slip   Stapelnok	gesloten	1300	1100	150	6000	1250	350	18,71
QP1311MR3R-ASCD	3 onderlatten	meermalig	Anti-slip   Stapelnok	gesloten	1300	1100	150	6000	1250	350	18,71
QP1311MB6R-ASCD	6 onderlatten	eenmalig	Anti-slip   Stapelnok	gesloten	1300	1100	150	6000	1250	800	19,52
QP1311MR6R-ASCD	6 onderlatten	meermalig	Anti-slip   Stapelnok	gesloten	1300	1100	150	6000	1250	800	19,52

## VRACHTLADINGEN

ARTIKEL	STANDAARD TRUCK*		JUMBO TRAILER*		20' HC CONTAINER*		40' HC CONTAINER*	
	STAPEL	TOTAAL	STAPEL	TOTAAL	STAPEL	TOTAAL	STAPEL	TOTAAL
QP1311MB3R-AS	15	330	17	408	16	160	16	336
QP1311MR3R-AS	15	330	17	408	16	160	16	336
QP1311MB6R-AS	15	330	17	408	16	160	16	336
QP1311MR6R-AS	15	330	17	408	16	160	16	336
QP1311MB3R-ASCD	15	330	17	408	16	160	16	336
QP1311MR3R-ASCD	15	330	17	408	16	160	16	336
QP1311MB6R-ASCD	15	330	17	408	16	160	16	336
QP1311MR6R-ASCD	15	330	17	408	16	160	16	336

\* Standaard truck: 13.60 x 2.44 - 2.48 x 2.65 m (L x b x h) / Jumbo trailer: 7.60-7.60 x 2.45 x 3.00 m (L x b x h) / 20' HC (binnenmaat): 5.90 x 2.35 x 2.70 m (L x b x h) / 40' HC (binnenmaat): 12.00 x 2.35 x 2.70 m (L x b x h)





QP1311MR3R-ASCD

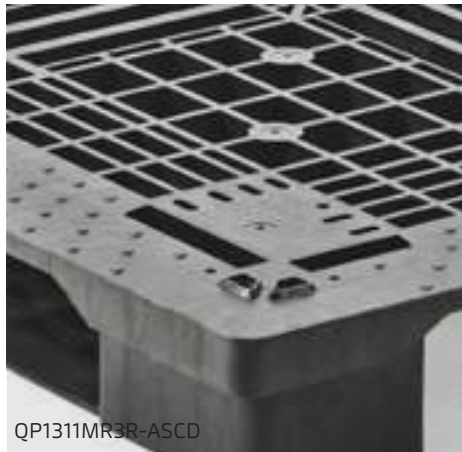

QP1311MR3R-ASCD



QP1311MR6R-AS



**BESCHIKBARE OPTIES**

-  ESD
-  BRANDVERTRAGEND

-  ANTI-SLIP
-  RAL-KLEUR

-  BEDRUKKING MET LOGO OF TEKST

"UITERMATE GESCHIKT VOOR  
GEBRUIK IN DE VOEDSEL EN  
FARMACEUTISCH  
INDUSTRIES"



QP1311MR3R-AS



1100 x 1300 mm



QP1311MR6R-ASCD



QP1311MR6R-AS



# 1100 X 1300 MM HEAVY

L	Light pallet
M	Medium pallet
H	Heavy pallet
↕	Meermalige pallet
→	Eenmalige pallet



QP1311HR3RL



## SPECIFICATIES

ARTIKEL	ONDERDEK	GEBRUIK	RAND	BOVENDEK	AFMETINGEN			LAADCAPACITEIT			GEWICHT
					LENGTE	BREEDTE	HOOGTE	STATISCH	DYNAMISCH	PALLETSTELLING	
QP1311HB3RL	3 onderlatten	eenmalig	L-rib	open	1300	1100	160	7500	1500	1250	21,99
QP1311HR3RL	3 onderlatten	meermalig	L-rib	open	1300	1100	160	7500	1500	1250	21,99
QP1311HB5RL	5 onderlatten	eenmalig	L-rib	open	1300	1100	160	7500	1500	1250	23,66
QP1311HR5RL	5 onderlatten	meermalig	L-rib	open	1300	1100	160	7500	1500	1250	23,66
QP1311HB3R-AS	3 onderlatten	eenmalig	Anti-slip   Stapelnok	open	1300	1100	158	7500	1500	1250	23,06
QP1311HR3R-AS	3 onderlatten	meermalig	Anti-slip   Stapelnok	open	1300	1100	158	7500	1500	1250	23,06
QP1311HB6R-AS	6 onderlatten	eenmalig	Anti-slip   Stapelnok	open	1300	1100	158	7500	1500	1250	23,55
QP1311HR6R-AS	6 onderlatten	meermalig	Anti-slip   Stapelnok	open	1300	1100	158	7500	1500	1250	23,55
QP1311HB3R-ASCD	3 onderlatten	eenmalig	Anti-slip   Stapelnok	gesloten	1300	1100	158	7500	1500	1250	24,55
QP1311HR3R-ASCD	3 onderlatten	meermalig	Anti-slip   Stapelnok	gesloten	1300	1100	158	7500	1500	1250	24,55
QP1311HB6R-ASCD	6 onderlatten	eenmalig	Anti-slip   Stapelnok	gesloten	1300	1100	158	7500	1500	1250	26,50
QP1311HR6R-ASCD	6 onderlatten	meermalig	Anti-slip   Stapelnok	gesloten	1300	1100	158	7500	1500	1250	26,50

## VRACHTLADINGEN

ARTIKEL	STANDAARD TRUCK*		JUMBO TRAILER*		20' HC CONTAINER*		40' HC CONTAINER*	
	STAPEL	TOTAAL	STAPEL	TOTAAL	STAPEL	TOTAAL	STAPEL	TOTAAL
QP1311HB3RL	15	330	17	408	16	160	16	336
QP1311HR3RL	15	330	17	408	16	160	16	336
QP1311HB5RL	15	330	17	408	16	160	16	336
QP1311HR5RL	15	330	17	408	16	160	16	336
QP1311HB3R-AS	15	330	17	408	16	160	16	336
QP1311HR3R-AS	15	330	17	408	16	160	16	336
QP1311HB6R-AS	15	330	17	408	16	160	16	336
QP1311HR6R-AS	15	330	17	408	16	160	16	336
QP1311HB3R-ASCD	15	330	17	408	16	160	16	336
QP1311HR3R-ASCD	15	330	17	408	16	160	16	336
QP1311HB6R-ASCD	15	330	17	408	16	160	16	336
QP1311HR6R-ASCD	15	330	17	408	16	160	16	336

\* Standaard truck: 13.60 x 2.44 - 2.48 x 2.65 m (L x b x h) / Jumbo trailer: 7.60-7.60 x 2.45 x 3.00 m (L x b x h) / 20' HC (binnenmaat): 5.90 x 2.35 x 2.70 m (L x b x h) / 40' HC (binnenmaat): 12.00 x 2.35 x 2.70 m (L x b x h)



QP1311HR5RL



QP1311HR3RL



QP1311HR5RL



**BESCHIKBARE OPTIES**



ESD



ANTI-SLIP



BEDRUKKING MET LOGO OF TEKST



BRANDVERTRAGEND



RAL-KLEUR



QP1311HR3R-AS



QP1311HR3R-ASCD

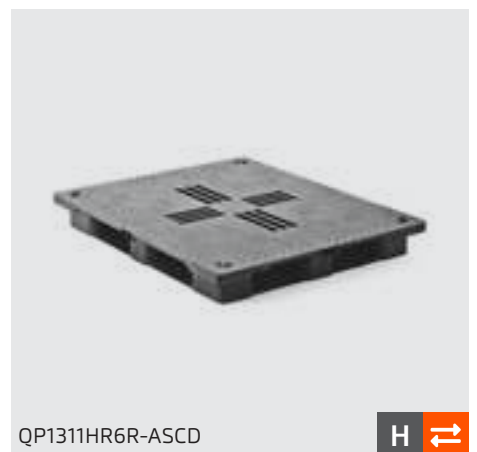

QP1311HR6R-ASCD



1100 x 1300 mm





# CHEMISCHE INDUSTRIE

Elke markt stelt eigen eisen aan de pallets die er gebruikt worden en dat geldt zeker voor de chemische industrie. Niet voor niets heeft deze een eigen CP pallet. Er is een grote diversiteit aan complexe, geautomatiseerde magazijnen en distributiecentra. Pallets vormen een onmisbaar onderdeel van deze moderne systemen. U wilt een pallet dat naadloos aansluit op uw handlingoplossing voor een betrouwbare, ononderbroken proces. Dat is precies wat Q-PALL u kan bieden. Q-PALL heeft een uiteenlopend assortiment: van CP1 t/m CP9. Uiteraard allemaal ontworpen met het oog op efficiëntie en kostenbesparing.





**ONZE PRODUCTEN**

**1140 X 1140 MM**

1140 x 1140 mm

# 1140 X 1140 MM LIGHT

L	Light pallet
M	Medium pallet
H	Heavy pallet
↕	Meermalige pallet
→	Eenmalige pallet



QP1140LR3RR



## SPECIFICATIES

ARTIKEL	ONDERDEK	GEBRUIK	RAND	BOVENDEK	AFMETINGEN			LAADCAPACITEIT			GEWICHT
					LENGTE	BREEDTE	HOOGTE	STATISCH	DYNAMISCH	PALLETSTELLING	
QP1140LR9F	9 pootjes nestbaar	eenmalig	-	open	1140	1140	150	2500	1000	0	7,53
QP1140LR9FR	9 pootjes nestbaar	eenmalig	✓	open	1140	1140	150	2500	1000	0	7,53
QP1140LR3R	3 onderlatten	eenmalig	-	open	1140	1140	150	2500	1000	0	9,36
QP1140LR3RR	3 onderlatten	eenmalig	✓	open	1140	1140	150	2500	1000	0	9,36

## VRACHTLADINGEN

ARTIKEL	STANDAARD TRUCK*		JUMBO TRAILER*		20' HC CONTAINER*		40' HC CONTAINER*	
	STAPEL	TOTAAL	STAPEL	TOTAAL	STAPEL	TOTAAL	STAPEL	TOTAAL
QP1140LR9F	55	1210	60	1560	55	550	55	1100
QP1140LR9FR	55	1210	60	1560	55	550	55	1100
QP1140LR3R	16	352	17	442	16	160	16	320
QP1140LR3RR	16	352	17	442	16	160	16	320

\* Standaard truck: 13.60 x 2.44 - 2.48 x 2.65 m (L x b x h) / Jumbo trailer: 7.60-7.60 x 2.45 x 3.00 m (L x b x h) / 20' HC (binnenmaat): 5.90 x 2.35 x 2.70 m (L x b x h) / 40' HC (binnenmaat): 12.00 x 2.35 x 2.70 m (L x b x h)





QP1140LR9FR



**BESCHIKBARE OPTIES**



ESD



ANTI-SLIP



BEDRUKKING MET LOGO OF TEKST



BRANDVERTRAGEND



RAL-KLEUR



QP1140LR9FR



"MAAKT OPTIMAAL  
GEBRUIK VAN  
LAADRUIMTEN DE  
OVERSEA CONTAINER"



QP1140LR3RR



1140 x 1140 mm

# 1140 X 1140 MM MEDIUM

L	Light pallet
M	Medium pallet
H	Heavy pallet
↕	Meermalige pallet
→	Eenmalige pallet



QP1140MR3R-PAS



## SPECIFICATIES

ARTIKEL	ONDERDEK	GEBRUIK	RAND	BOVENDEK	AFMETINGEN			LAADCAPACITEIT			GEWICHT
					LENGTE	BREEDTE	HOOGTES	STATISCH	DYNAMISCH	PALLETSTELLING	
QP1140MB3R	3 onderlatten	eenmalig	-	open	1140	1140	156	7500	1375	250	15,31
QP1140MB3RR	3 onderlatten	eenmalig	✓	open	1140	1140	156	7500	1375	250	15,31
QP1140MR3R	3 onderlatten	meermalig	-	open	1140	1140	156	7500	1375	250	15,12
QP1140MR3RR	3 onderlatten	meermalig	✓	open	1140	1140	156	7500	1375	250	15,12
QP1140MR6R	6 onderlatten	meermalig	-	open	1140	1140	156	7500	1375	250	16,95
QP1140MR6RR	6 onderlatten	meermalig	✓	open	1140	1140	156	7500	1375	250	16,95
QP1140MB6R	6 onderlatten	eenmalig	-	open	1140	1140	156	7500	1375	250	16,99
QP1140MB6RR	6 onderlatten	eenmalig	✓	open	1140	1140	156	7500	1375	250	16,99
QP1140MB3R-PAS	3 onderlatten	eenmalig	Anti-slip Stapelnok	open	1140	1140	150	7500	1375	250	13,51
QP1140MR3R-PAS	3 onderlatten	meermalig	Anti-slip Stapelnok	open	1140	1140	150	7500	1375	250	13,36
QP1140MB6R-PAS	6 onderlatten	eenmalig	Anti-slip Stapelnok	open	1140	1140	150	7500	1375	250	14,25
QP1140MR6R-PAS	6 onderlatten	meermalig	Anti-slip Stapelnok	open	1140	1140	150	7500	1375	250	14,27

## VRACHTLADINGEN

ARTIKEL	STANDAARD TRUCK*		JUMBO TRAILER*		20' HC CONTAINER*		40' HC CONTAINER*	
	STAPEL	TOTAAL	STAPEL	TOTAAL	STAPEL	TOTAAL	STAPEL	TOTAAL
QP1140MB3R	17	374	19	494	17	170	17	357
QP1140MB3RR	17	374	19	494	17	170	17	357
QP1140MR3R	17	374	19	494	17	170	17	357
QP1140MR3RR	17	374	19	494	17	170	17	357
QP1140MR6R	17	374	19	494	17	170	17	357
QP1140MR6RR	17	374	19	494	17	170	17	357
QP1140MB6R	17	374	19	494	17	170	17	357
QP1140MB6RR	17	374	19	494	17	170	17	357
QP1140MB3R-PAS	17	374	19	494	17	170	17	357
QP1140MR3R-PAS	17	374	19	494	17	170	17	357
QP1140MB6R-PAS	17	374	19	494	17	170	17	357
QP1140MR6R-PAS	17	374	19	494	17	170	17	357

\* Standaard truck: 13.60 x 2.44 - 2.48 x 2.65 m (L x b x h) / Jumbo trailer: 7.60-7.60 x 2.45 x 3.00 m (L x b x h) / 20' HC (binnenmaat): 5.90 x 2.35 x 2.70 m (L x b x h) / 40' HC (binnenmaat): 12.00 x 2.35 x 2.70 m (L x b x h)



QP1140MR6R-PAS



QP1140MR3R-PAS

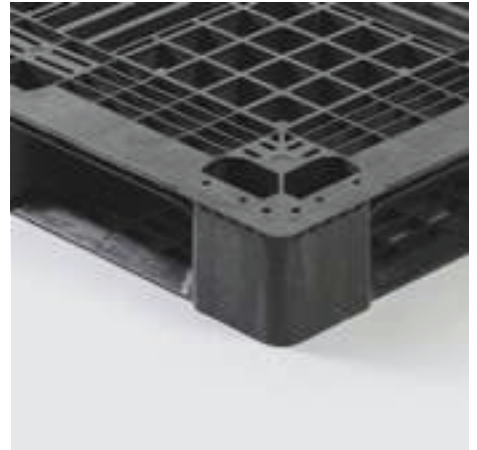

### BESCHIKBARE OPTIES



ESD



ANTI-SLIP



BEDRUKKING MET LOGO OF TEKST



BRANDVERTRAGEND



RAL-KLEUR



QP1140MR6RR

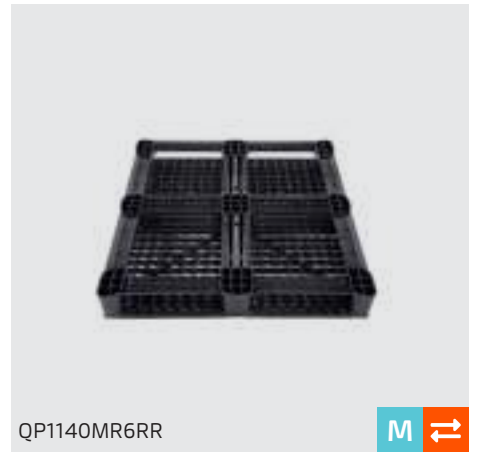

QP1140MR6RR



CP8 QP1140MR6RRH



1140 x 1140 mm

# 1140 X 1140 MM HEAVY

L	Light pallet
M	Medium pallet
H	Heavy pallet
↕	Meermalige pallet
→	Eenmalige pallet



QP1140HR6RR



## SPECIFICATIES

ARTIKEL	ONDERDEK	GEBRUIK	RAND	BOVENDEK	AFMETINGEN			LAADCAPACITEIT			GEWICHT
					LENGTE	BREEDTE	HOOGTE	STATISCH	DYNAMISCH	PALLETSTELLING	
QP1140HR3R	3 onderlatten	eenmalig	-	open	1140	1140	170	7500	1500	1000	24,50
QP1140HR3RR	3 onderlatten	eenmalig	✓	open	1140	1140	170	7500	1500	1000	24,50
QP1140HP3R	3 onderlatten	meermalig	-	open	1140	1140	170	7500	1500	1000	24,50
QP1140HP3RR	3 onderlatten	meermalig	✓	open	1140	1140	170	7500	1500	1000	24,50
QP1140HR6R	6 onderlatten	eenmalig	-	open	1140	1140	170	7500	1500	1250	26,00
QP1140HR6RR	6 onderlatten	eenmalig	✓	open	1140	1140	170	7500	1500	1250	26,00
QP1140HP6R	6 onderlatten	meermalig	-	open	1140	1140	170	7500	1500	1250	25,50
QP1140HP6RR	6 onderlatten	meermalig	✓	open	1140	1140	170	7500	1500	1250	25,50
QP1140HB3R-ASCD	3 onderlatten	eenmalig	Anti-slip   Stapelnok	gesloten	1140	1140	160	7500	1750	1000	23,76
QP1140HR3R-ASCD	3 onderlatten	meermalig	Anti-slip   Stapelnok	gesloten	1140	1140	160	7500	1750	1000	23,52
QP1140HB6R-ASCD	6 onderlatten	eenmalig	Anti-slip   Stapelnok	gesloten	1140	1140	160	7500	1750	1250	26,01
QP1140HR6R-ASCD	6 onderlatten	meermalig	Anti-slip   Stapelnok	gesloten	1140	1140	160	7500	1750	1250	25,70

## VRACHTLADINGEN

ARTIKEL	STANDAARD TRUCK*		JUMBO TRAILER*		20' HC CONTAINER*		40' HC CONTAINER*	
	STAPEL	TOTAAL	STAPEL	TOTAAL	STAPEL	TOTAAL	STAPEL	TOTAAL
QP1140HR3R	15	330	17	442	15	150	15	300
QP1140HR3RR	15	330	17	442	15	150	15	300
QP1140HP3R	15	330	17	442	15	150	15	300
QP1140HP3RR	15	330	17	442	15	150	15	300
QP1140HR6R	15	330	17	442	15	150	15	300
QP1140HR6RR	15	330	17	442	15	150	15	300
QP1140HP6R	15	330	17	442	15	150	15	300
QP1140HP6RR	15	330	17	442	15	150	15	300
QP1140HB3R-ASCD	16	352	18	468	16	160	16	320
QP1140HR3R-ASCD	16	352	18	468	16	160	16	320
QP1140HB6R-ASCD	16	352	18	468	16	160	16	320
QP1140HR6R-ASCD	16	352	18	468	16	160	16	320

\* Standaard truck: 13.60 x 2.44 - 2.48 x 2.65 m (L x b x h) / Jumbo trailer: 7.60-7.60 x 2.45 x 3.00 m (L x b x h) / 20' HC (binnenmaat): 5.90 x 2.35 x 2.70 m (L x b x h) / 40' HC (binnenmaat): 12.00 x 2.35 x 2.70 m (L x b x h)



QP1140HR3RR



QP1140HR3RR



QP1140HR6RR



**BESCHIKBARE OPTIES**



ESD



ANTI-SLIP



BEDRUKKING MET LOGO OF TEKST



BRANDVERTRAGEND



RAL-KLEUR



QP1140HR6R-ASCD



QP1140HR3R-ASCD



QP1140HR6R-ASCD



1140 x 1140 mm



A photograph of a warehouse interior. In the foreground, a forklift is lifting a stack of approximately 12 grey plastic pallets. The pallets are arranged in a grid pattern. In the background, there are high industrial shelving units (pallet racks) filled with various boxes and goods. Some of the racks have yellow labels with the number '56' and '55'. The lighting is bright, typical of a warehouse environment.

**ONZE PRODUCTEN**

**1200 X 1200 MM**

1200 x 1200 mm

# 1200 X 1200 MM LIGHT

L	Light pallet
M	Medium pallet
H	Heavy pallet
↕	Meermalige pallet
→	Eenmalige pallet



QP1212LR3RR



## SPECIFICATIES

ARTIKEL	ONDERDEK	GEBRUIK	RAND	BOVENDEK	AFMETINGEN			LAADCAPACITEIT			GEWICHT
					LENGTE	BREEDTE	HOOGTE	STATISCH	DYNAMISCH	PALLETSTELLING	
QP1212LR9F	9 pootjes nestbaar	eenmalig	-	open	1200	1200	150	2500	1000	0	8,34
QP1212LR9FR	9 pootjes nestbaar	eenmalig	✓	open	1200	1200	150	2500	1000	0	8,34
QP1212LR3R	3 onderlatten	eenmalig	-	open	1200	1200	150	2500	1000	0	10,29
QP1212LR3RR	3 onderlatten	eenmalig	✓	open	1200	1200	150	2500	1000	0	10,29

## VRACHTLADINGEN

ARTIKEL	STANDAARD TRUCK*		JUMBO TRAILER*		20' HC CONTAINER*		40' HC CONTAINER*	
	STAPEL	TOTAAL	STAPEL	TOTAAL	STAPEL	TOTAAL	STAPEL	TOTAAL
QP1212LR9F	55	1210	60	1440	55	320	55	760
QP1212LR9FR	55	1210	60	1440	55	320	55	760
QP1212LR3R	16	352	17	408	16	276	16	230
QP1212LR3RR	16	352	17	408	16	276	16	230

\* Standaard truck: 13.60 x 2.44 - 2.48 x 2.65 m (L x b x h) / Jumbo trailer: 7.60-7.60 x 2.45 x 3.00 m (L x b x h) / 20' HC (binnenmaat): 5.90 x 2.35 x 2.70 m (L x b x h) / 40' HC (binnenmaat): 12.00 x 2.35 x 2.70 m (L x b x h)





QP1212LR9FR



### BESCHIKBARE OPTIES



ESD



ANTI-SLIP



BEDRUKKING MET LOGO OF TEKST



BRANDVERTRAGEND



RAL-KLEUR



QP1212LR9FR



1200 x 1200 mm

# 1200 X 1200 MM MEDIUM

L	Light pallet
M	Medium pallet
H	Heavy pallet
↕	Meermalige pallet
→	Eenmalige pallet



QP1212MR3RR



## SPECIFICATIES

ARTIKEL	ONDERDEK	GEBRUIK	RAND	BOVENDEK	AFMETINGEN			LAADCAPACITEIT			
					LENGTE	BREEDTE	HOOGTE	STATISCH	DYNAMISCH	PALLETSTELLING	GEWICHT
QP1212MB3R	3 onderlatten	eenmalig	-	open	1200	1200	156	7500	1375	250	15,90
QP1212MB3RR	3 onderlatten	eenmalig	✓	open	1200	1200	156	7500	1375	250	15,90
QP1212MR3R	3 onderlatten	meermalig	-	open	1200	1200	156	7500	1375	250	15,90
QP1212MR3RR	3 onderlatten	meermalig	✓	open	1200	1200	156	7500	1375	250	15,90
QP1212MB6R	6 onderlatten	eenmalig	-	open	1200	1200	156	7500	1375	250	17,66
QP1212MB6RR	6 onderlatten	eenmalig	✓	open	1200	1200	156	7500	1375	250	17,66
QP1212MR6R	6 onderlatten	meermalig	-	open	1200	1200	156	7500	1375	250	17,66
QP1212MR6RR	6 onderlatten	meermalig	✓	open	1200	1200	156	7500	1375	250	17,66

## VRACHTLADINGEN

ARTIKEL	STANDAARD TRUCK*		JUMBO TRAILER*		20' HC CONTAINER*		40' HC CONTAINER*	
	STAPEL	TOTAAL	STAPEL	TOTAAL	STAPEL	TOTAAL	STAPEL	TOTAAL
QP1212MB3R	16	352	19	456	17	180	17	290
QP1212MB3RR	16	352	19	456	17	180	17	290
QP1212MR3R	16	352	19	456	17	180	17	290
QP1212MR3RR	16	352	19	456	17	180	17	290
QP1212MB6R	16	352	19	456	17	180	17	290
QP1212MB6RR	16	352	19	456	17	180	17	290
QP1212MR6R	16	352	19	456	17	180	17	290
QP1212MR6RR	16	352	19	456	17	180	17	290

\* Standaard truck: 13.60 x 2.44 - 2.48 x 2.65 m (L x b x h) / Jumbo trailer: 7.60-7.60 x 2.45 x 3.00 m (L x b x h) / 20' HC (binnenmaat): 5.90 x 2.35 x 2.70 m (L x b x h) / 40' HC (binnenmaat): 12.00 x 2.35 x 2.70 m (L x b x h)



QP1212MR6RR



**BESCHIKBARE OPTIES**



ESD



ANTI-SLIP



BEDRUKKING MET LOGO OF TEKST



BRANDVERTRAGEND



RAL-KLEUR



QP1212MR3RR

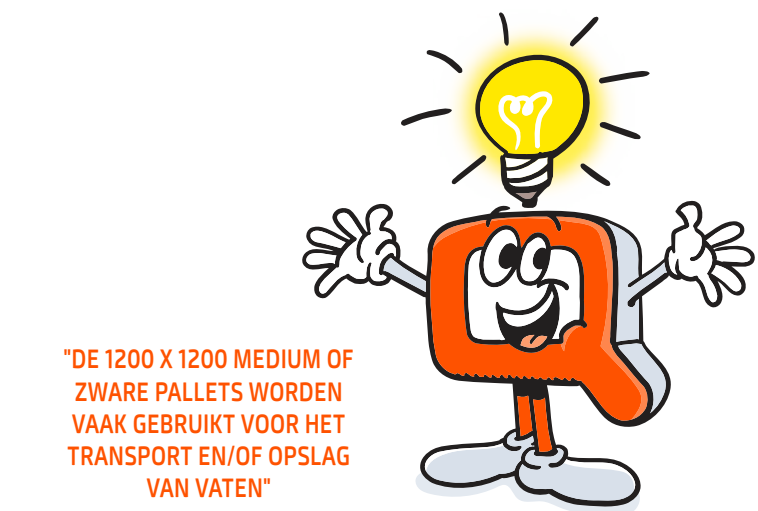

"DE 1200 X 1200 MEDIUM OF ZWARE PALLETS WORDEN VAAK GEBRUIKT VOOR HET TRANSPORT EN/OF OPSLAG VAN VATEN"



QP1212MR6RR



1200 x 1200 mm

# 1200 X 1200 MM HEAVY

L	Light pallet
M	Medium pallet
H	Heavy pallet
↕	Meermalige pallet
→	Eenmalige pallet



QP1212HP6RR



## SPECIFICATIES

ARTIKEL	ONDERDEK	GEBRUIK	RAND	BOVENDEK	AFMETINGEN			LAADCAPACITEIT			
					LENGTE	BREEDTE	HOOGTE	STATISCH	DYNAMISCH	PALLETSTELLING	GEWICHT
QP1212HR3R	3 onderlatten	eenmalig	-	open	1200	1200	170	7500	1500	1000	26,0
QP1212HR3RR	3 onderlatten	eenmalig	✓	open	1200	1200	170	7500	1500	1000	26,0
QP1212HP3R	3 onderlatten	meermalig	-	open	1200	1200	170	7500	1500	1250	26,0
QP1212HP3RR	3 onderlatten	meermalig	✓	open	1200	1200	170	7500	1500	1250	26,0
QP1212HR6R	6 onderlatten	eenmalig	-	open	1200	1200	170	7500	1500	1250	27,0
QP1212HR6RR	6 onderlatten	eenmalig	✓	open	1200	1200	170	7500	1500	1250	27,0
QP1212HP6R	6 onderlatten	meermalig	-	open	1200	1200	170	7500	1500	1375	26,5
QP1212HP6RR	6 onderlatten	meermalig	✓	open	1200	1200	170	7500	1500	1375	26,5

## VRACHTLADINGEN

ARTIKEL	STANDAARD TRUCK*		JUMBO TRAILER*		20' HC CONTAINER*		40' HC CONTAINER*	
	STAPEL	TOTAAL	STAPEL	TOTAAL	STAPEL	TOTAAL	STAPEL	TOTAAL
QP1212HR3R	15	330	17	408	15	108	15	270
QP1212HR3RR	15	330	17	408	15	108	15	270
QP1212HP3R	15	330	17	408	15	108	15	270
QP1212HP3RR	15	330	17	408	15	108	15	270
QP1212HR6R	15	330	17	408	15	108	15	270
QP1212HR6RR	15	330	17	408	15	108	15	270
QP1212HP6R	15	330	17	408	15	108	15	270
QP1212HP6RR	15	330	17	408	15	108	15	270

\* Standaard truck: 13.60 x 2.44 - 2.48 x 2.65 m (L x b x h) / Jumbo trailer: 7.60-7.60 x 2.45 x 3.00 m (L x b x h) / 20' HC (binnenmaat): 5.90 x 2.35 x 2.70 m (L x b x h) / 40' HC (binnenmaat): 12.00 x 2.35 x 2.70 m (L x b x h)



QP1212HR6RR vatversie

H →



QP1212HR6RR vatversie

H →



QP1212HR6RR vatversie

H →

### BESCHIKBARE OPTIES



ESD



ANTI-SLIP



BEDRUKKING MET LOGO OF TEKST



BRANDVERTRAGEND



RAL-KLEUR



QP1212HR3RR

H →



QP1212HR3RR

H →

1200 x 1200 mm





**ONZE PRODUCTEN**

**SPECIALS**

SPECIALS

# KUNSTSTOF OPZETRANDE EN DEKSELS



## KUNSTSTOF OPZETRANDE

### SPECIFICATIES

ARTIKEL	AANTAL SCHARNIEREN	DIKTE SCHARNIEREN	DIKTE WAND	AFMETINGEN		
				LENGTE	BREEDTE	HOOGTE
QPKVOUWR6080-4	4	1,25	29	800	600	200
QPKVOUWR1208-4	4	1,25	29	1200	800	200
QPKVOUWR1208-6	6	1,25	29	1200	800	200
QPKVOUWR1210-4	4	1,25	29	1200	1000	200
QPKVOUWR1210-6	6	1,25	29	1200	1000	200
QPKVOUWR1212-4	4	1,25	29	1200	1200	200

## KUNSTSTOF DEKSELS

### SPECIFICATIES

ARTIKEL	AFMETINGEN (BUITENMAAT)		
	LENGTE	BREEDTE	HOOGTE
QPRDECK6080	800	600	50
QPRDECK1208	1200	800	50
QPRDECK1210	1200	1000	50





# BOTTLEGUARD



BOTTLEGUARD8H

## SPECIFICATIES

ARTIKEL	AFMETINGEN			LAADCAPACITEIT		GEWICHT
	LENGTE	BREEDTE	HOOGTE	STATISCH	DYNAMISCH	
Bottleguard8L	1200	1000	380	4500	1750	17
Bottleguard8H	1200	1000	423	4500	1750	18



BOTTLEGUARD8L



BOTTLEGUARD8H



BOTTLEGUARD8L



BOTTLEGUARD8L



BOTTLEGUARD8H

# FREEZER SPACERS



TYPE1 QPFSI1210-BLACK

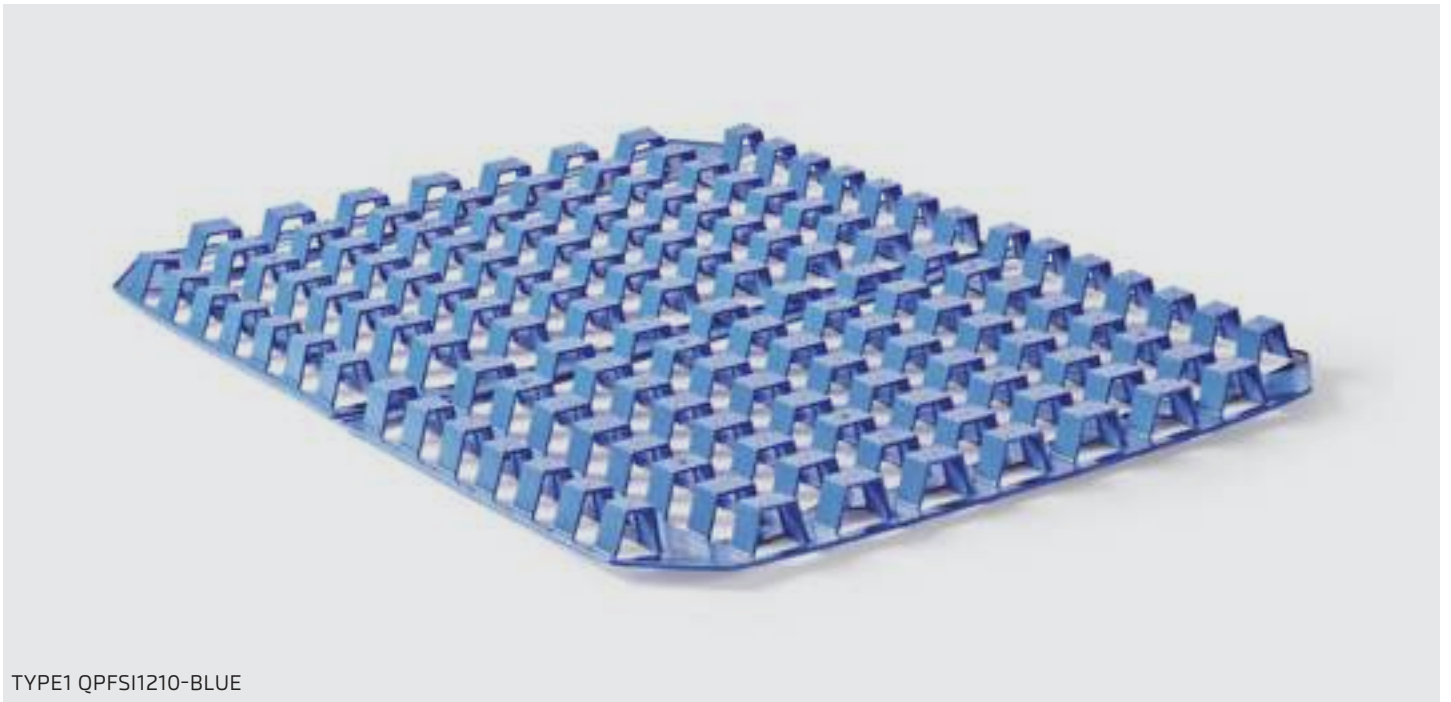

TYPE1 QPFSI1210-BLUE

## SPECIFICATIES

ARTIKEL	AFMETINGEN			LAADCAPACITEIT		GEWICHT	COULEUR
	LENGTE	BREEDTE	HOOGTE	STATISCH	DYNAMISCH		
QPFSI1208-Black	1200	800	50	3000	1500	2,96	Zwart
QPFSI1208-Blue	1200	800	50	3000	1500	2,96	Blauw
QPFSI1210-Black	1200	1000	50	3000	1500	3,68	Zwart
QPFSI1210-Blue	1200	1000	50	3000	1500	3,68	Blauw
QPFSI1208-Black	1200	800	50	2000	1000	2,72	Zwart
QPFSI1210-Black	1200	1000	50	2000	1000	3,36	Zwart



QPFSII1208-BLACK



QPFSII1208-BLACK



QPFSII1210-BLACK



QPFSII1210-BLACK

#### MILIEU

De freezer-spacers zijn vervaardigd van 100% gerecycled materiaal en kunnen ook aan het einde van hun levensduur weer volledig worden gerecycled. Daarnaast komt ook de sterk verminderde energie consumptie tijdens bevroering volledig ten goede aan het milieu.

#### PRAKTISCH

Het lage gewicht en open ontwerp maakt dat de freezer-spacers makkelijk te hanteren en reinigen zijn. De spacers nesten eenvoudig in elkaar wanneer ze niet in gebruik zijn waardoor ze een minimale hoeveelheid ruimte innemen.

#### KOSTENEFFICIËNT

Vanwege de robuuste structuur van High-Density Polyethyleen weerstaat de freezer-spacer temperaturen tussen  $-50^{\circ}\text{C}$  en  $+90^{\circ}\text{C}$  en is deze bestand tegen zuren en chemicaliën. Hierdoor hebben ze een lange levensduur, zelfs onder de zwaarste toepassingen.

#### EFFICIËNT

De open profielen resulteren in maximale lucht contact wat weer zorgt voor sneller en efficiënter invriezen van de hele pallet lading.

# KUNSTSTOF LEKBAK



## KUNSTSTOF LEKBAK

### SPECIFICATIES

ARTIKEL	AFMETINGEN			LAADCAPACITEIT		GEWICHT	CAPACITEIT (L)
	LENGTE	BREEDTE	HOOGTE	STATISCH	DYNAMISCH		
QPBIN120L	1200	800	312	5000	1500	28	120

## KUNSTSTOF LEKBAK + ROOSTER

### SPECIFICATIES

ARTIKEL	MATERIAAL	AFMETINGEN			LAADCAPACITEIT		GEWICHT	CAPACITEIT (L)
		LENGTE	BREEDTE	HOOGTE	STATISCH	DYNAMISCH		
QPBIN120L-GRIDG	Gegalvaniseerd	1200	800	-	-	-	27	-













# FARMACEUTISCHE INDUSTRIE

In de farmaceutische industrie is hygiëne een absolute must. Zonder hygiëne loopt het productieproces gevaar en raken medicijnen verontreinigd. Ongenode gasten als schimmels, insecten en bacteriën zijn absoluut ondenkbaar. Juist in deze omgeving komen onze pallets het meest tot hun recht. Kunststof is van nature al hygiënischer dan hout. De hygiënepallets van Q-PALL zijn bovendien extra zorgvuldig afgewerkt en volledig glad uitgevoerd. Geen ruimtes en naden waarin vuil zich kan ophopen. Daardoor kunt u zich richten op de belangrijke zaken.

**Q-PALL BV**  
Taylorweg 2  
NL-5466 AE Veghel  
Nederland  
Telefoon: +31 413 353 111  
E-mail: info@qpall.com

[www.qpall.com](http://www.qpall.com)

**QPALL**<sup>®</sup>  
P L A S T I C P A L L E T S